

DiscountLED

LIGHTING AND SIGNS

CREATING INDUSTRY STANDARDS



LIGHTING CATALOGUE

www.discountled.us

CONTENTS

- 1 SHOEBOX LIGHT
- 4 POST TOP POLE
- 7 MINI WALLPACKS LIGHT
- 09 TRADITIONAL WALLPACKS
- 12 ROTATABLE WALLPACK
- 15 UFO HIGH BAYS
- 18 LINEAR HIGH BAYS
- 21 TUBE LIGHTS
- 24 INTEGRATED TUBES T5
- 27 INTEGRATED COOLER LIGHTS
- 29 FLOOD LIGHTS
- 34 RECESSED/DOWNLIGHTS
- 38 UP & DOWN WALLPACK
- 40 CANOPY LIGHTS
- 43 TROFFER LIGHTS
- 46 PANEL LIGHTS



CONTENTS

LED BULBS	51
LED CORNCOB BULB	56
LED BOLLARDS	61
LED GROW LIGHTS	63
POLE, TENON & MOUNTS	66
CONTEMPORARY EXTRUION	70
LED T-BAR PANEL	73
LED GAS PRICE SIGNS	75
LED DIGITAL SIGNS	78
CUSTOM PRINTED CEILING PANELS	83
LED EXIT SIGN	85
STRIP LIGHT, LED NEON FLEX, ROPE LIGHT & POWER SUPPLIES	87



DiscountLED



LED SHOEBOX LIGHT
PARKING LOT/ AREA LIGHT FIXTURE

UL & DLC CERTIFIED

01



www.discountled.us



(877) 740-4248

LED SHOEBOX LIGHT

PARKING LOT / AREA LIGHT FIXTURE

OVERVIEW

These outdoor Shoebox lights are specially manufactured for parking lots, LED SHOEBOX Lighting series can be widely used in Urban roads, industrial areas, residential areas, sidewalks, squares, parks, schools, gardens etc.

FEATURES

- ✓ Seoul Chip, high CRI.
- ✓ IP65 driver, input voltage 100-277VAC.
- ✓ Adjusted through output cable with 1-10V.
- ✓ Easy to install and operate.
- ✓ Energy saving, long lifespan.
- ✓ Light is soft and uniform, safe to eyes.
- ✓ No UV or IR in the beam.



150W



300W



450W

PRODUCT SPECIFICATION

-	150W LED	240W LED	300W LED	450W LED
Power Wattage	150W	240W	300W	450W
Kelvins	5700K	5700K	5700K	5700K
Lumens	21087 LMS	33600 LMS	40463 LMS	60,749 LMS
Efficacy (Lm/Watt)	142LM/Watt	140LM/Watt	134LM/Watt	135LM/Watt
Input Voltage	120-277V & 450V	100-277V & 480V	120-277V & 450V	120-277V
IP Grade	IP65	IP65	IP65	IP65
Bracket Type	AM Bracket	AM Bracket	AM Bracket	AM Bracket
Life Span	50000 Hours	50000 Hours	50000 Hours	50000 Hours
Certification	UL/DLC	UL/DLC	UL/DLC	UL/DLC
Warranty	5 Years	5 Years	5 Years	5 Years

LED SHOEBOX LIGHT

PARKING LOT / AREA LIGHT FIXTURE

Photometric/Dimensions

150 W

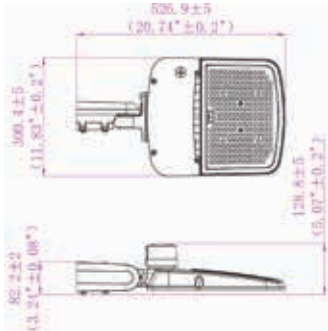

Luminous Intensity Distribution Curve

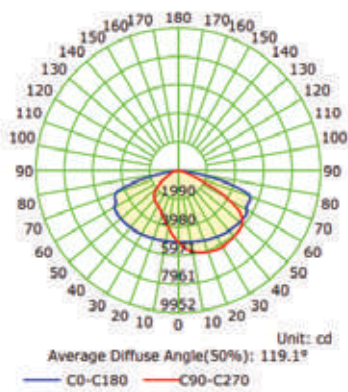

240 W

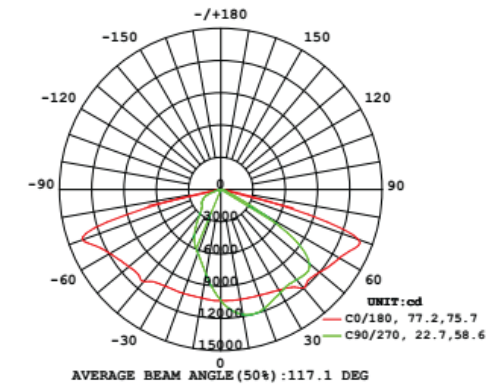
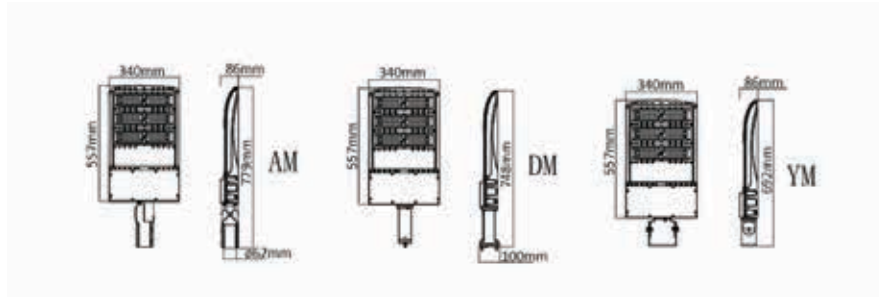

300 W

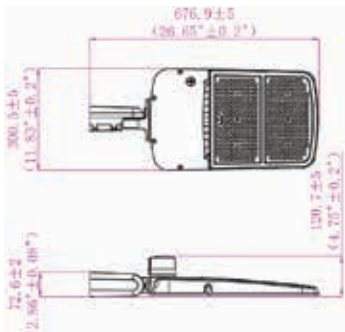

Luminous Intensity Distribution Curve

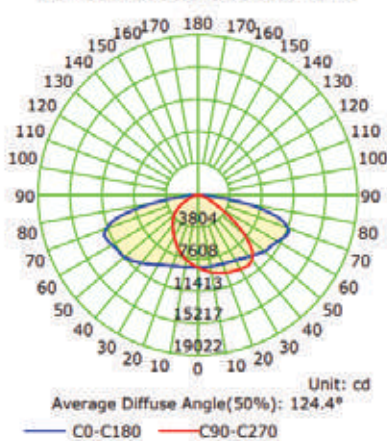

450 W

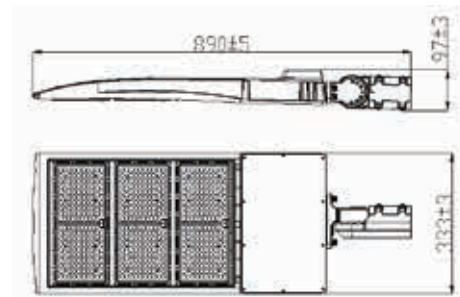

Luminous Intensity Distribution Curve

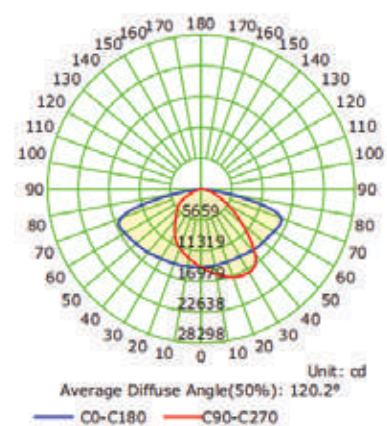

DiscountLED



LED POST TOP POLE LIGHT
PATHWAY POLE / COMMERCIAL AREA

UL & DLC CERTIFIED

LED POST TOP POLE LIGHT

PATHWAY POLE / COMMERCIAL AREA

OVERVIEW

Post Top Pole fixture is designed for circular distribution, our LED Type V Area Light is perfect for roadways, intersections, or commercial parking lots. Housed in die-cast aluminum, the long-lasting LED distributes light evenly across all angles for at least 50000 hours.

FEATURES

- ✓ Seoul Chip, high CRI.
- ✓ IP65 driver, input voltage 100-277VAC.
- ✓ Adjusted through output cable with 1-10V.
- ✓ Easy to install and operate.
- ✓ Energy saving, long lifespan.
- ✓ Light is soft and uniform, safe to eyes.
- ✓ No UV or IR in the beam.

PRODUCT SPECIFICATION

-	50W LED	75W LED	150W LED
Power Wattage	50W	75W	150W
Kelvins	5000K	CCT Tunable (3000K, 4000K & 5000K)	5000K
Lumens	6750 LMS	10,125 LMS	20,250 LMS
Efficacy (Lm/Watt)	135LM/Watt	135LM/Watt	135LM/Watt
Input Voltage	100-277V	100-277V	100-277V
IP Grade	IP65	IP65	IP65
Life Span	50000 Hours	50000 Hours	50000 Hours
Certification	UL/DLC	UL/DLC	UL/DLC
Warranty	5 Years	5 Years	5 Years



LED POST TOP POLE LIGHT

PATHWAY POLE / COMMERCIAL AREA

Photometric/Dimensions

50 W

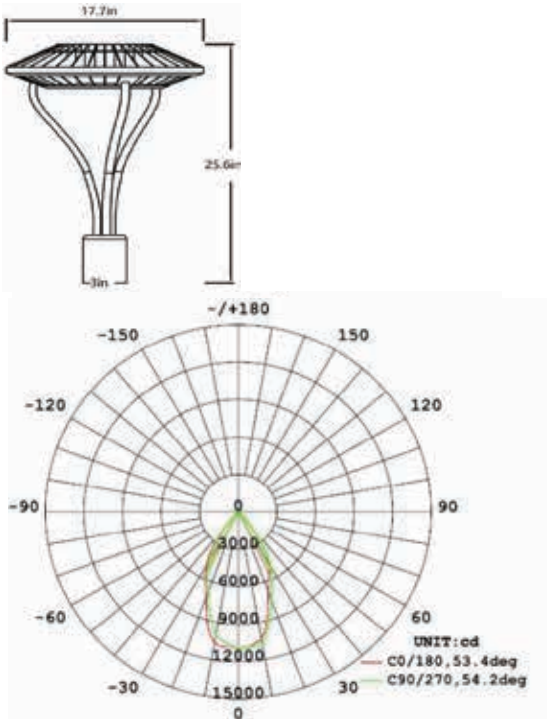

75 W

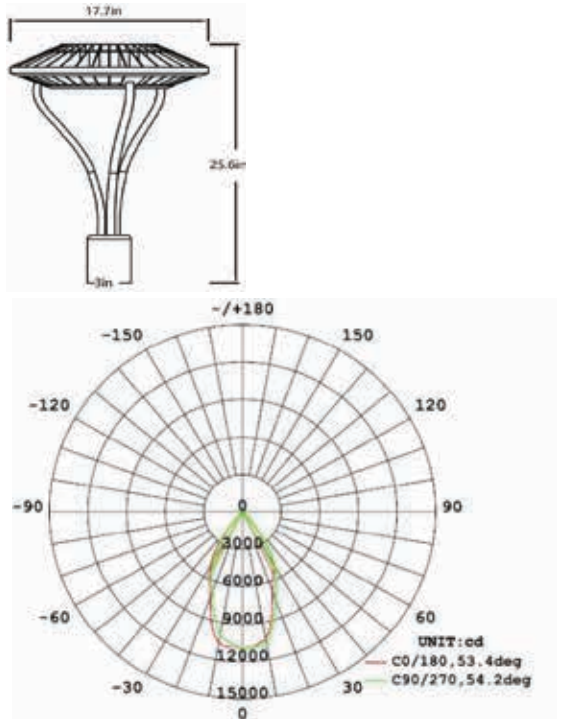

150 W

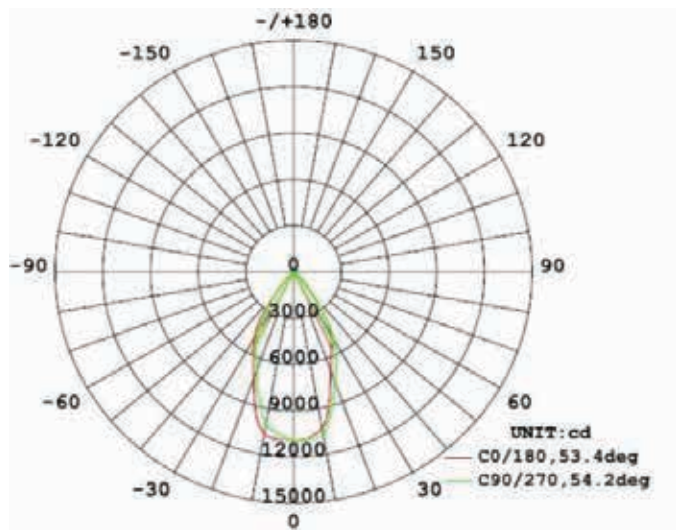
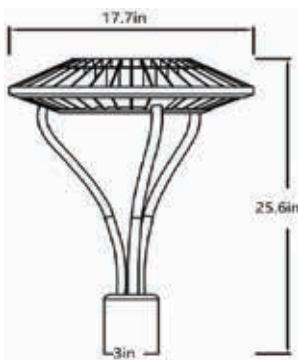

DiscountLED

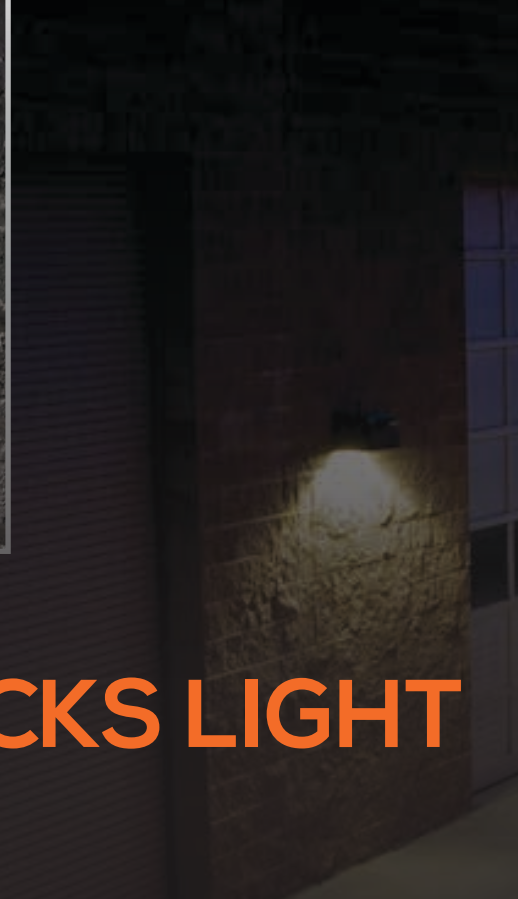

LED MINI WALLPACKS LIGHT
RESIDENTIAL AREAS / SIDEWALKS

UL & DLC CERTIFIED

LED MINI WALLPACKS

RESIDENTIAL AREAS / SIDEWALKS

OVERVIEW

These outdoor mini wall pack lights are specially manufactured to cover small areas and it can be widely used in industrial areas, residential areas, sidewalks, squares, parks, schools, gardens, etc.



FEATURES

- ✓ Easy to install and operate.
- ✓ Energy-saving, long lifespan.
- ✓ Instant start, NO flickering, NO humming.
- ✓ Light is soft and uniform, safe to eyes.
- ✓ No UV or IR in the beam.
- ✓ Photocell Compatible.
- ✓ IP65 driver, input voltage 100-277VAC.
- ✓ Outdoor Rated

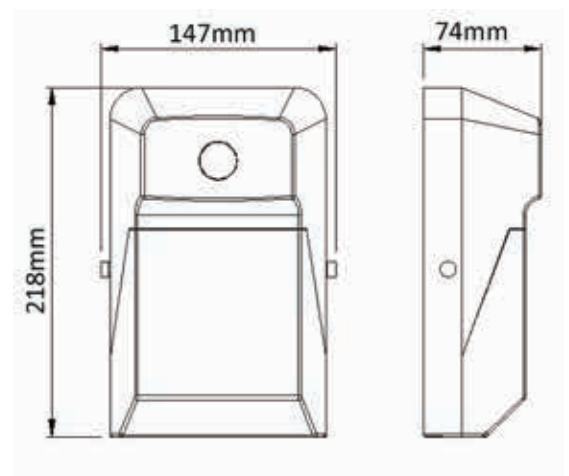

PRODUCT SPECIFICATION

	15W LED	20W LED
Power Wattage	15W	20W
Efficacy (Lm/Watt)	135LM/Watt	135LM/Watt
Input Voltage	100-277V	100-277V
Lumens	2025	2700
Kelvins	5700K	5700K
Certification	UL/DLC	UL/DLC
Life Span	50000 Hours	50000 Hours
Photocell	With/Without	With/Without
Warranty	5 Years	5 Years

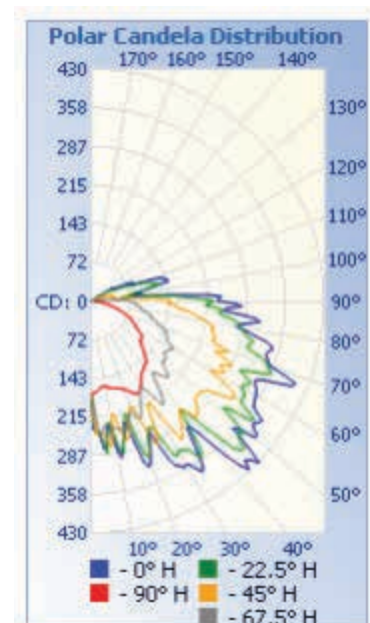

DiscountLED



LED TRADITIONAL WALLPACKS
RESIDENTIAL AREAS / SIDEWALKS

UL & DLC CERTIFIED

LED TRADITIONAL WALLPACKS LIGHTS

RESIDENTIAL AREAS / SIDEWALKS

OVERVIEW

These outdoor wall pack lights are specially manufactured to cover large areas and it can be widely used in industrial , residential building, sidewalks, squares, parks, schools, gardens, etc.



FEATURES

- ✓ Easy to install and operate.
- ✓ Energy-saving, long lifespan.
- ✓ Instant start, NO flickering, NO humming.
- ✓ Light is soft and uniform, safe to eyes.
- ✓ No UV or IR in the beam.
- ✓ Photocell Compatible.
- ✓ IP65 driver, input voltage 120-277VAC.



PRODUCT SPECIFICATION

-	60W LED	120W LED
Power Wattage :	60W	120W
Efficacy (Lm/Watt)	139LM/Watt	136LM/Watt
Input Voltage	120-277V	120-277V
Lumens	8113	15798
Kelvins	5700K	5700K
Certification	UL/DLC	UL/DLC
Life Span	50000 Hours	50000 Hours
Warranty	5 Years	5 Years

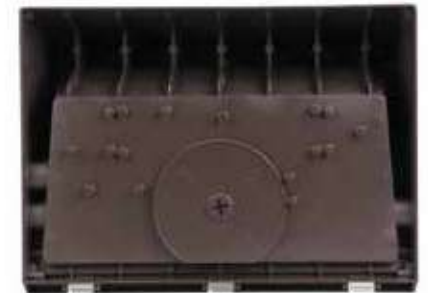

LED TRADITIONAL WALLPACKS LIGHTS

RESIDENTIAL AREAS / SIDEWALKS

Photometric/Dimensions

60 W

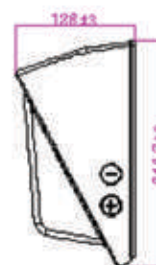
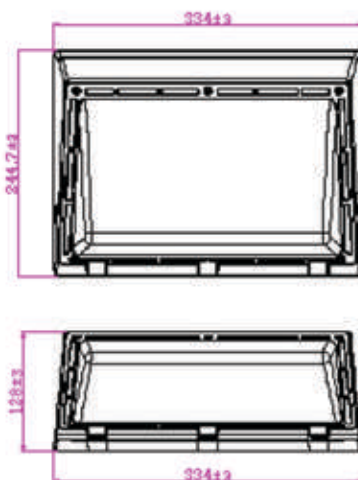
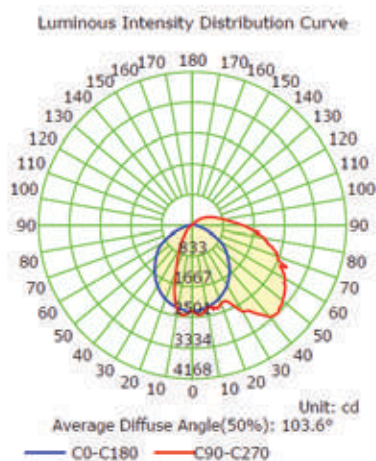

120 W

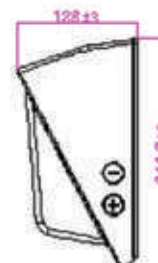
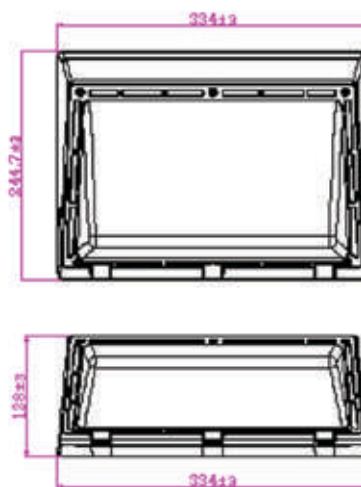
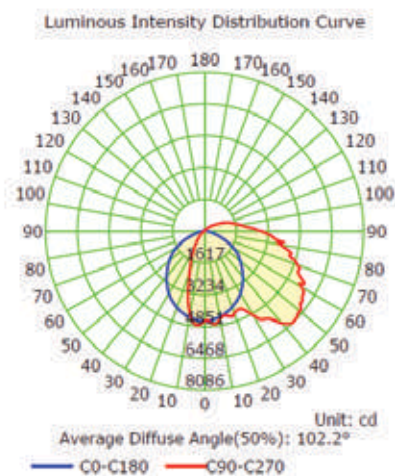

DiscountLED



LED ROTATABLE WALLPACK
RESIDENTIAL AREAS / SIDEWALKS

UL & DLC CERTIFIED



ROTATABLE WALLPACKS

RESIDENTIAL AREAS / SIDEWALKS

OVERVIEW

These Rotatable LED outdoor wall Packs are manufactured with a Rotating option which helps angle the light where its more needed, very bright nice looking and durable with 5 years of warranty



FEATURES

- ✓ Easy to install and operate.
- ✓ Energy-saving, long lifespan.
- ✓ Instant start, NO flickering, NO humming.
- ✓ Light is soft and uniform, safe to eyes.
- ✓ No UV or IR in the beam.
- ✓ Photocell Compatible.
- ✓ IP65 driver, input voltage 100-277VAC.
- ✓ Adjustable Lighting



PRODUCT SPECIFICATION

-	40W LED	80W LED	120W LED
Power Wattage :	40W	80W	120W
Efficacy (Lm/Watt)	130LM/Watt	130LM/Watt	130LM/Watt
Input Voltage	100-277V	100-277V	100-277V
Lumens	5200	10400	15600
Kelvins	5700K	5700K	5700K
Certification	UL/DLC	UL/DLC	UL/DLC
Life Span	50000 Hours	50000 Hours	50000 Hours
Warranty	5 Years	5 Years	5 Years



ROTATABLE WALLPACKS

RESIDENTIAL AREAS / SIDEWALKS

Photometric/Dimensions

40 W

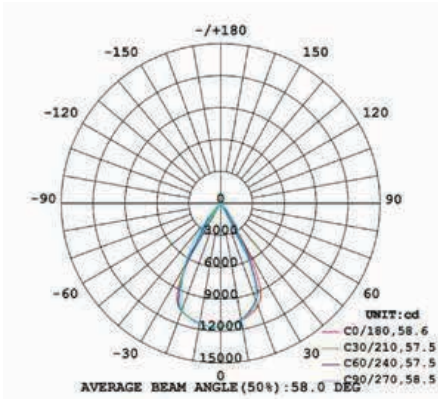
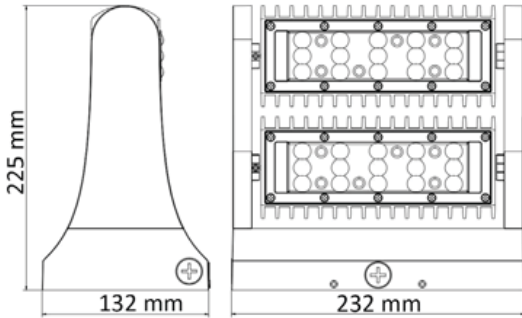

80 W

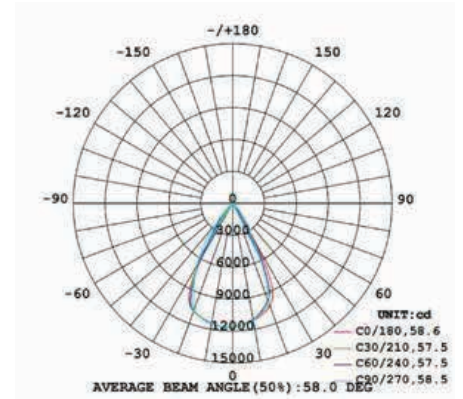
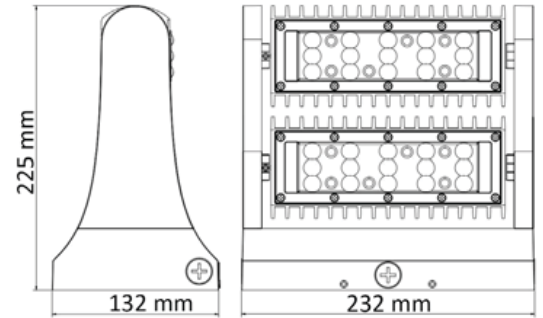

120 W

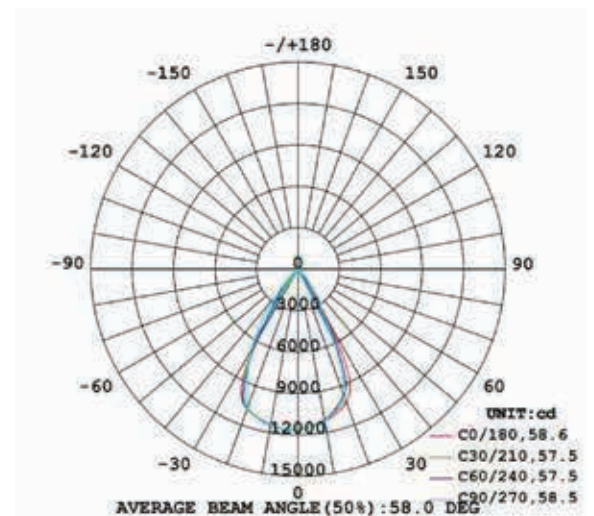
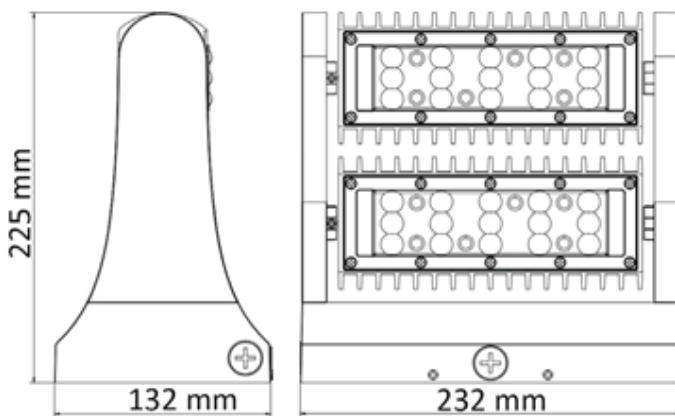

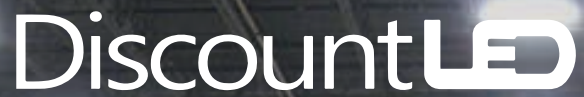

DiscountLED



LED UFO HIGH BAYS
COMMERCIAL AREAS / WAREHOUSES / FACTORIES



LED UFO HIGH BAYS

COMMERCIAL AREAS / WARE HOUSES LIGHT

OVERVIEW

This LED UFO High bay is designed and engineered as maintenance free, energy-contamination of the night sky, while providing highly effective delivered lumens for outdoor and indoor illumination at Warehouses, garages, gas stations, public spaces, schools, etc.



FEATURES

- ✓ UL DLC certified
- ✓ Input voltage 100-277VAC
- ✓ No UV or IR in the beam
- ✓ Light is soft and uniform, safe to eyes.
- ✓ CRI > 80
- ✓ Greenland Eco-friendly without mercury.
- ✓ China brand IP65 driver,



PRODUCT SPECIFICATION

-	150W LED	240W LED	300W LED
Power Wattage :	150W	240W	300W
Efficacy (Lm/Watt)	140LM/Watt	140LM/Watt	140LM/Watt
Input Voltage	100-277V	100-277V	100-277V
Lumens	21000	33600	42000
Kelvins	5700K	5700K	5700K
Certification	UL/DLC	UL/DLC	UL/DLC
Life Span	50000 Hours	50000 Hours	50000 Hours
Motion Sensor:	With/Without	With/Without	With/Without
Warranty	5 Years	5 Years	5 Years

LED UFO HIGH BAYS

COMMERCIAL AREAS / WARE HOUSES LIGHT

Photometric/Dimensions

150 W

Pendent

Surface-mounted

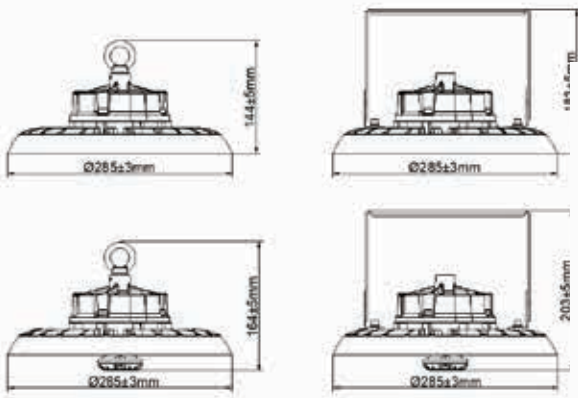

240 W

Pendent

Surface-mounted

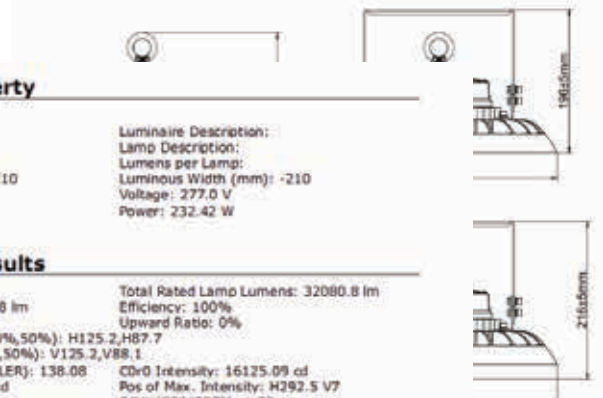

Luminaire Property

Luminaire Manufacturer:	Luminaire Description:
Luminaire Category:	Lamp Description:
Lamp Catalog:	Lumens per Lamp:
Number of Lamps:	Luminous Width (mm): -210
Luminous Length (mm): -210	Voltage: 277.0 V
Luminous Height (mm):	Power: 232.42 W
Current: 0.892 A	
Power Factor: 0.941	

Photometric Results

CIE Class: Direct	Total Rated Lamp Lumens: 32080.8 lm
Measurement Flux: 32080.8 lm	Efficiency: 100%
Downward Ratio: 100%	Upward Ratio: 0%
Horizontal Diffuse Angle(10%,50%): H125.2,H87.7	
Vertical Diffuse Angle(10%,50%): V125.2,V88.1	
Luminaire Efficacy Rating (LER): 138.08	CD0 Intensity: 16125.09 cd
Max. Intensity: 16147.97 cd	Pos of Max. Intensity: H292.5 V7
S/MH(CD/C180): 1.32	S/MH(C90/C270): 1.32

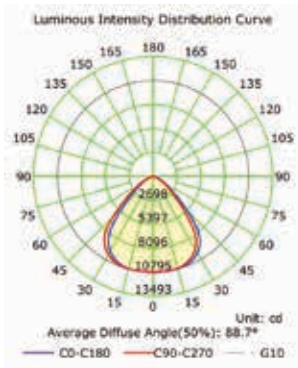

Picture Of Luminaire



Luminous Intensity Distribution Curve

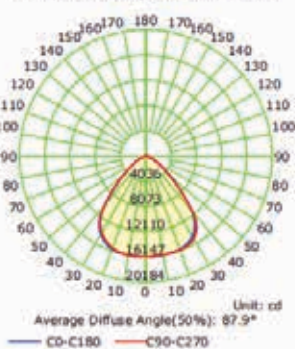

C Plane (°):0.0-360.0: 22.5
 Test Lab:
 Test Type: TYPE C
 Temperature: 25.5 °C
 Operator:

Gamma Plane (°):0.0-180.0:1.0
 Test Device: GPM-3000
 Distance: 14.140 m [K=1.0000]
 Humidity:
 Inspector:

300 W

Pendent

Surface-mounted

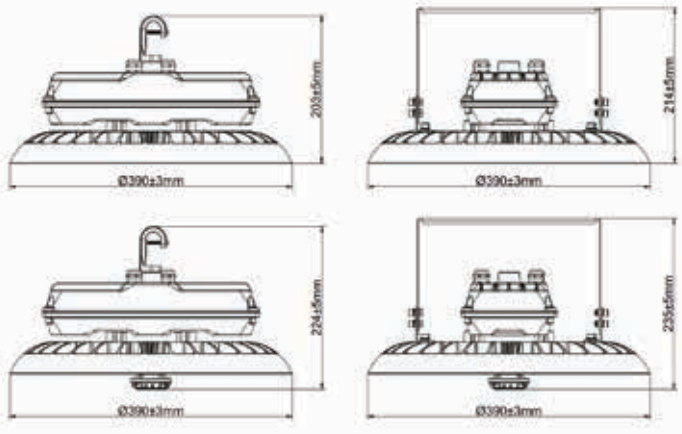

Luminous Intensity Distribution Curve

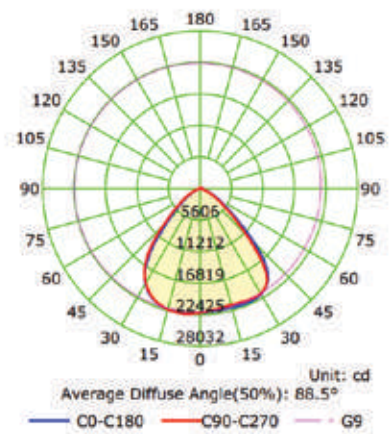

DiscountLED



LED LINEAR HIGH BAYS
WAREHOUSE / SPORT FACILITIES / GYMS

UL & DLC CERTIFIED

LED LINEAR HIGH BAYS

WAREHOUSE / SPORT FACILITIES

OVERVIEW

The large space between ceiling and floor necessitates that a linear high bay light provide a high lumen output and the light needs to be focused down and out from the fixture. Led Linear high bays providing highly effective delivered lumens for indoor illumination at Warehouse, storage and gyms.



FEATURES

- ✓ UL DLC certified
- ✓ Input voltage 100-277VAC
- ✓ No UV or IR in the beam
- ✓ Light is soft and uniform, safe to eyes.
- ✓ CRI >80
- ✓ Greenland Eco-friendly without mercury.
- ✓ China brand IP65 driver,



PRODUCT SPECIFICATION

-	110W LED	165W LED	220W LED
Power Wattage :	110W	165W	220W
Efficacy (Lm/Watt)	145LM/Watt	145LM/Watt	145LM/Watt
Input Voltage	100-277V	100-277V	100-277V
Lumens	15950	23925	31900
Kelvins	5700K	5700K	5700K
Certification	UL/DLC	UL/DLC	UL/DLC
Life Span	50000 Hours	50000 Hours	50000 Hours
Photocell	With/Without	With/Without	With/Without
Size:	2FT	2FT	2FT & 4FT
Warranty	5 Years	5 Years	5 Years



LED LINEAR HIGH BAYS

WAREHOUSE / SPORT FACILITIES

Photometric/Dimensions

110 W

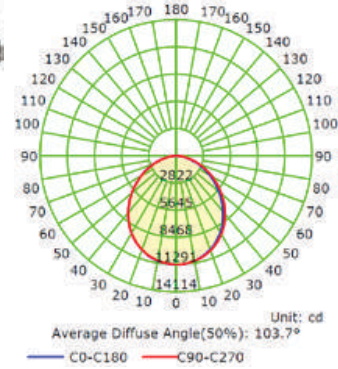
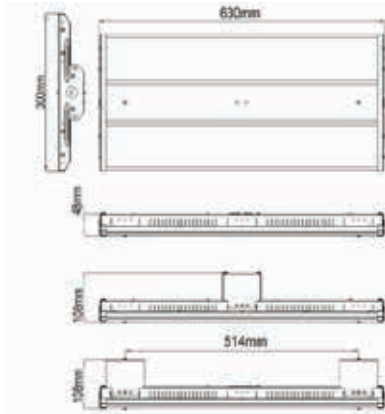

165 W

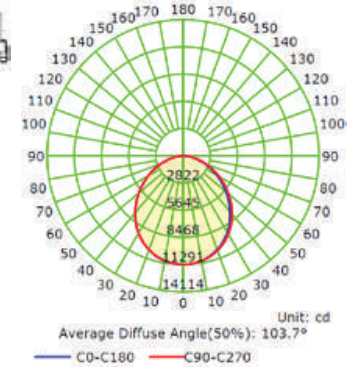
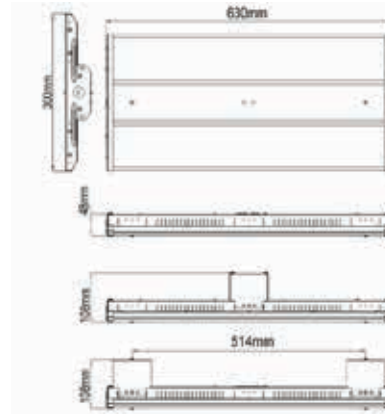

220 W

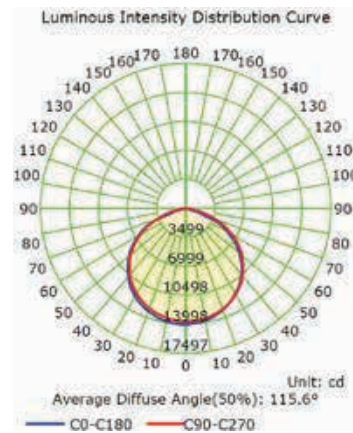
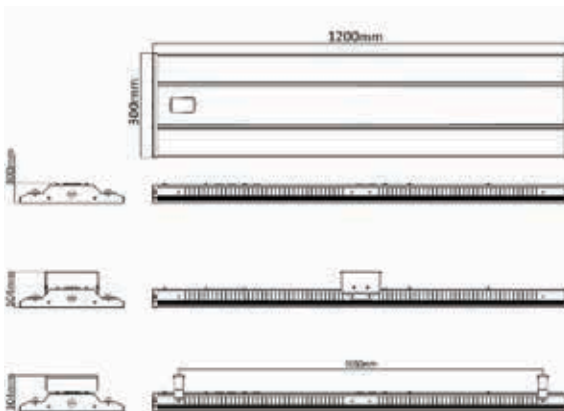

DiscountLED



LED TUBE LIGHTS

DRAWING ROOM / FACTORIES

UL & DLC CERTIFIED



LED TUBE LIGHTS

DRAWING ROOM / FACTORIES



OVERVIEW

Super Tech Leds T8 4ft Tube emits high lumens. It's a replacement for old florescent fixtures and lasts 3 times longer, which reduces costly repairs and replacements. The tube has built in driver. It's constructed of die cast aluminum, steel, and has a shatterproof lens.

PRODUCT SPECIFICATION

-	T8 2FT 24" LED Tube	T8 3FT 36" LED Tube	T8 4 FT 48" LED Tube	T8 8 FT 96" LED Tube
Size	2FT 24"	3FT 36"	4FT 48"	8FT 96"
Power	10W	15W	20W	40W & 50W
Input Voltage	AC 100-277Vac	AC 100-277Vac	AC 100-277Vac	AC 100-277Vac
Lumens	1050 Lumens	1600 Lumens	2200 Lumens	4800LM & 6000LM
Kelvins	3000K,5000K & 6000K	3000K,5000K & 6000K	3000K,4000K,5000K & 6000K	3000K,5000K & 6000K
Cover Type	Clear,Frosted,Stripy	Clear ,Frosted & Stripy	Clear ,Frosted & Stripy	Clear ,Frosted & Stripy
CRI	>80Ra	>80Ra	>80Ra	>80Ra
Driver	Built In	Built In	Built In	Built In
Material	AL&PC Cover	AL&PC Cover	AL&PC Cover	AL&PC Cover
Base Type	G13	G13	G13	G13,FA8,R17D
Installation	Ballast Bypass	Ballast Bypass	Ballast Bypass	Ballast Bypass
Certification	UL,ETL OR DLC	UL,ETL OR DLC	UL,ETL OR DLC	UL,ETL OR DLC
Warranty	3-5 Years	3-5 Years	3-5 Years	3-5 Years

LED TUBE LIGHTS

DRAWING ROOM / FACTORIES

Photometric/Dimensions

2 FT

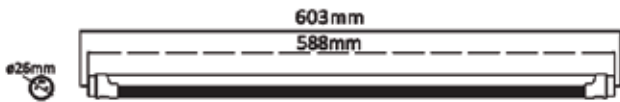

4 FT

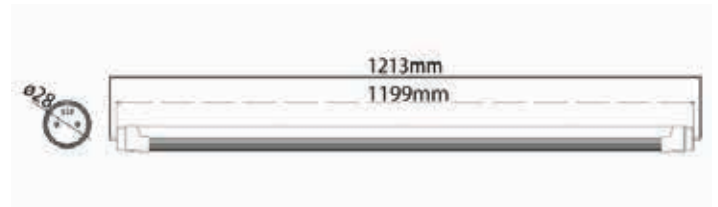
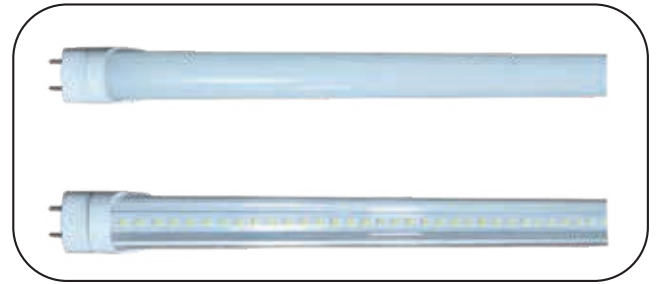

8 FT

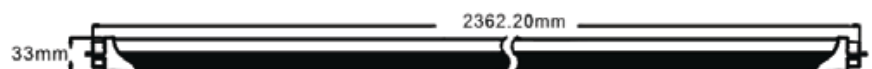
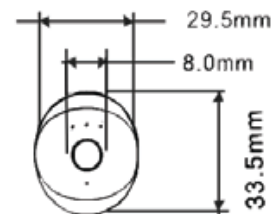
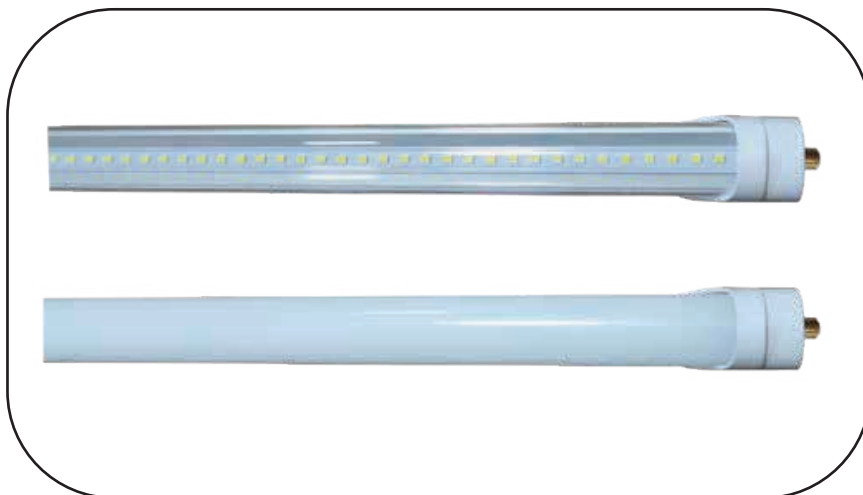

DiscountLED



LED INTEGRATED TUBES T5

SUPER STORES / OFFICES

UL & DLC CERTIFIED



LED INTEGRATED TUBES T5

SUPER STORES / OFFICES



OVERVIEW

Perfect for lighting large indoor areas, Linkable LED shop lights are the modern-day solution to the problems that arise due to inadequate lighting conditions. Apart from being Stylish and energy-efficient, these lights allow daisy-chaining. LED integrated t5 tubes are suitable for use in vast indoor areas, such as hallways and corridors.

PRODUCT SPECIFICATION

-	Integrated Tube 2FT	Integrated Tube 3FT	Integrated Tube 4FT
Size:	2FT 24"	3FT 36"	4FT 48"
Power:	10W	15W	24W
Input Voltage:	AC 100-277Vac	AC 100-277Vac	AC 100-277Vac
Lumens	1250 Lumens	1875 Lumens	2750 Lumens
Kelvins	6000K	6000K	6000K
Cover Type	Clear ,Frosted & Stripy	Clear ,Frosted & Stripy	Clear ,Frosted & Stripy
CRI	>80Ra	>80Ra	>80Ra
Accessories	Clips & Power Cord 8" Wire	Clips & Power Cord 8" Wire	Clips & Power Cord 8" Wire
Material	AL&PC Cover	AL&PC Cover	AL&PC Cover
Installation :	Plug in Play	Plug in Play	Plug in Play
Certification	ETL/DLC	ETL/DLC	ETL/DLC
Warranty	3 Years	3 Years	3 Years

LED INTEGRATED TUBES

DRAWING ROOM / FACTORIES

FEATURES

- ✓ ETL certified.
- ✓ Easy to install and operate.
- ✓ Connect Up To 6 Lights.
- ✓ Energy-saving, long lifespan.
- ✓ Free Accessories in Box.
- ✓ Light is soft and uniform, safe to eyes.
- ✓ Aluminum body, Glass Cover, Aluminum Heat Sink .
- ✓ No UV or IR in the beam.
- ✓ Instant start, NO flickering, NO humming.
- ✓ Photocell Compatible.
- ✓ 3-Year Warranty



PRODUCT SPECIFICATION

-	Integrated Tube 5FT	Integrated Tube 6FT	Integrated Tube 8FT
Size:	5FT 60"	6FT 72"	8FT 96"
Power:	32W	36W	60W
Input Voltage:	AC 100-277Vac	AC 100-277Vac	AC 100-277Vac
Lumens	4000 Lumens	4500 Lumens	7500 Lumens
Kelvins	6000K	6000K	6000K
Cover Type	Clear ,Frosted & Stripy	Clear ,Frosted & Stripy	Clear ,Frosted & Stripy
CRI	>80Ra	>80Ra	>80Ra
Accessories	Clips & Power Cord 8" Wire	Clips & Power Cord 8" Wire	Clips & Power Cord 8" Wire
Material	AL&PC Cover	AL&PC Cover	AL&PC Cover
Installation :	Plug in Play	Plug in Play	Plug in Play
Certification	ETL/DLC	ETL/DLC	ETL/DLC
Warranty	3 Years	3 Years	3 Years



DiscountLED

LED INTEGRATED COOLER LIGHTS
SHOPPING CENTERS COOLERS

UL & DLC CERTIFIED

LED INTEGRATED COOLER TUBE

SHOPPING CENTERS COOLERS

OVERVIEW

Super Tech Leds Integrated cooler fixture lights gives your cooling space a bright modern look .The sleek style shines light in 3 angles and make the products more pop up. The design is constructed from solid aluminum finish and can be use in any type of cooling space eg,gas stations , shopping centers coolers .



FEATURES

- ✓ ETL DLC certified.
- ✓ Vapor Proof.
- ✓ Easy to install and operate.
- ✓ Connect Up To 6 Lights.
- ✓ Energy-saving, long lifespan.
- ✓ Free Accessories in Box.
- ✓ Light is soft and uniform, safe to eyes.



PRODUCT SPECIFICATION

-	Integrated Tube 5FT	Integrated Tube 6FT
Size	5FT 60"	6FT 72"
Power	32W	40W
Input Voltage	AC 100-277Vac	AC 100-277Vac
Lumens	4000 Lumens	5000 Lumens
Kelvins	6000K	6000K
Cover Type	Clear ,Frosted & Stripy	Clear ,Frosted & Stripy
CRI	>80Ra	>80Ra
Accessories	Clips & Power Cord 8" Wire	Clips & Power Cord 8" Wire
Material	AL&PC Cover	AL&PC Cover
Max Connection	9 Pcs	8 Pcs
Certification	ETL DLC	ETL DLC
Warranty	3 Years	3 Years

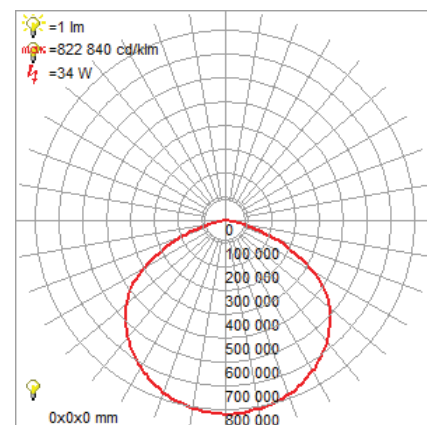



DiscountLED

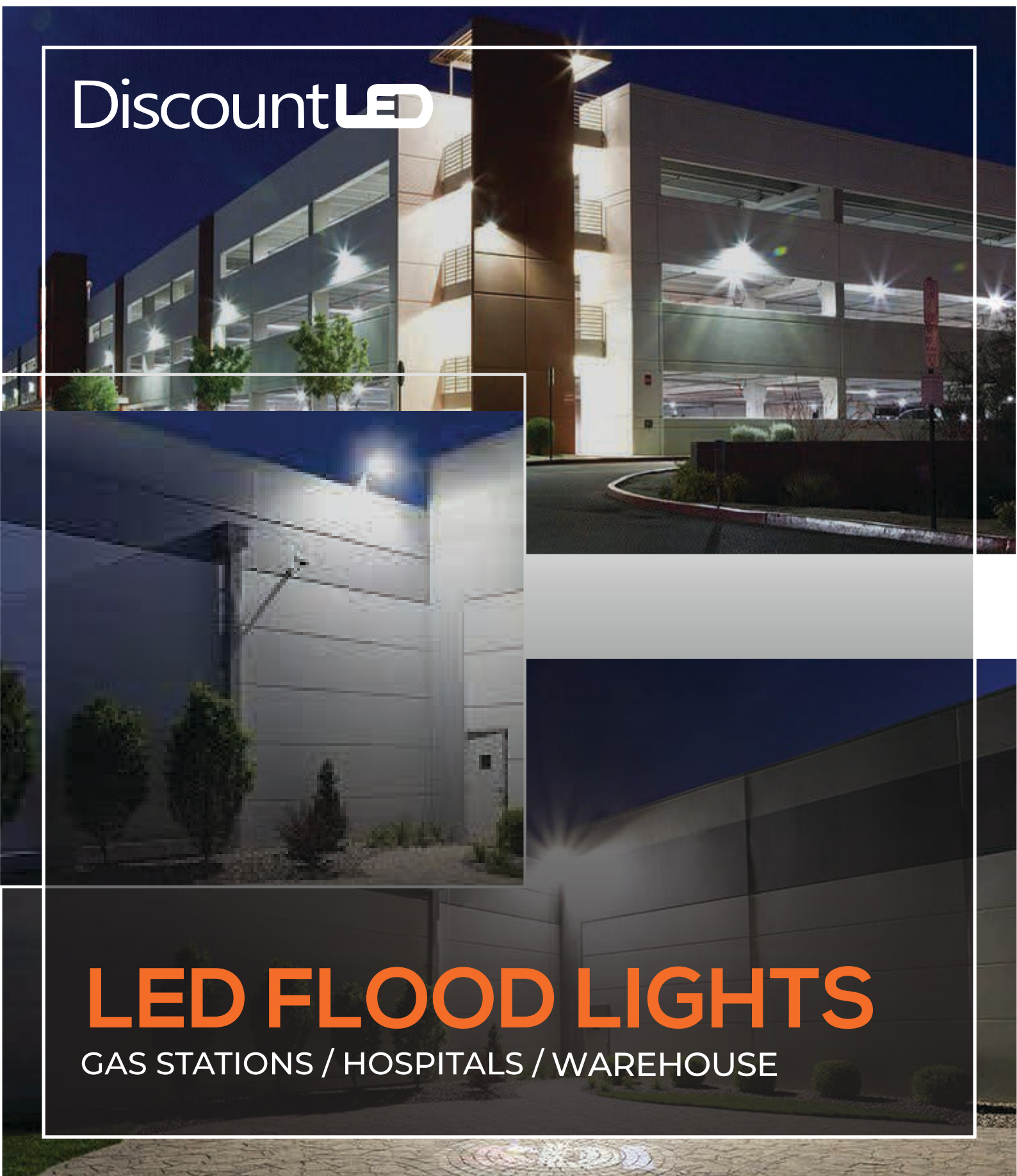

LED FLOOD LIGHTS

GAS STATIONS / HOSPITALS / WAREHOUSE

UL & DLC CERTIFIED

LED SLIM FLOOD LIGHTS

GAS STATIONS / HOSPITALS / WAREHOUSE

OVERVIEW

This LED Flood Light is designed and engineered as maintenance free, energy-contamination of the night sky, while providing highly effective delivered lumens for outdoor illumination at hotels, garages, gas stations, public spaces, schools, universities, hospitals, factory floor, libraries, square, supermarkets, railway stations, advertising lighting, etc.



FEATURES

- ✓ Light is soft and uniform, safe to eyes.
- ✓ Seoul Semiconductor Chip, high CRI.
- ✓ Greenland Eco-friendly without mercury.
- ✓ IP65 driver, input voltage 100-277VAC
- ✓ No UV or IR in the beam
- ✓ China brand IP65 driver
- ✓ 60%~80% Energy Savings

PRODUCT SPECIFICATION

-	50W LED	80W LED	150W LED	200W LED	300W LED
Power Wattage :	50W	80W	150W	200W	300W
Kelvins	5700K	5700K	5700K	5700K	5700K
Lumens	6400 LM	10320 LM	22500 LM	25000 LMS	43500 LMS
Efficacy (Lm/Watt)	128LM/W	129LM/W	150LM/W	125LM/W	145LM/W
Input Voltage	120-277V	120-277V	120-277V	100-277V	120-277V
IP Grade	IP65	IP65	IP65	IP65	IP65
Life Span	50,000 Hours	50,000 Hours	50,000 HOURS	50,000 HOURS	50,000 HOURS
Certification	UL/DLC	UL/DLC	UL/DLC	UL/DLC	UL/DLC
Warranty	5 Years	5 Years	5 YEARS	5 YEARS	5 YEARS

LED SLIM FLOOD LIGHTS

GAS STATIONS / HOSPITALS / FACTORY

Photometric/Dimensions

50W

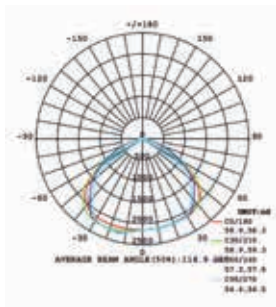
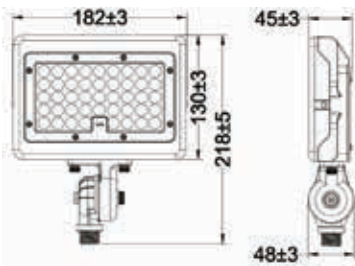

80W

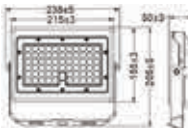
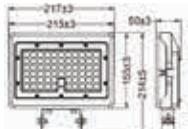
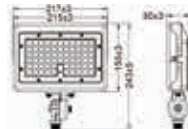

INTENSITY DISTRIBUTION DIAGRAM IN C BEAMS

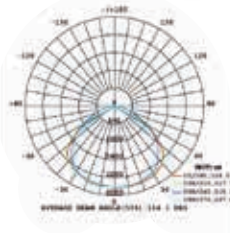

150W

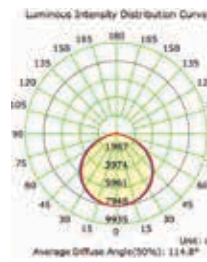
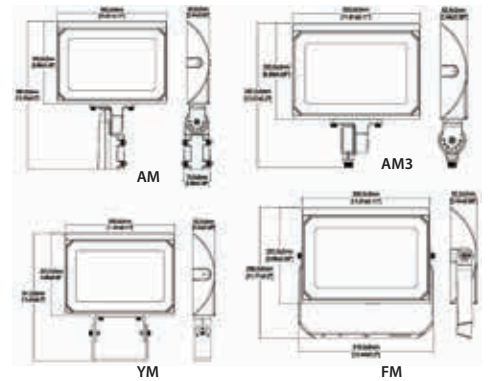

200W

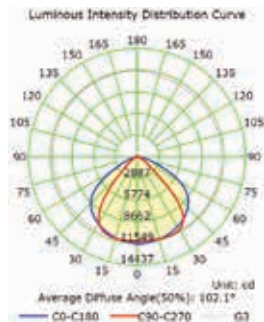
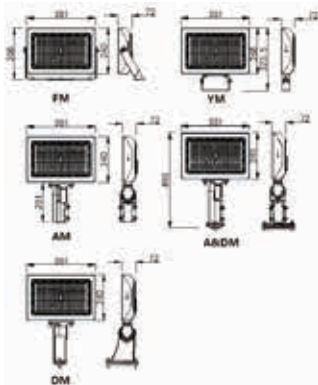

300W

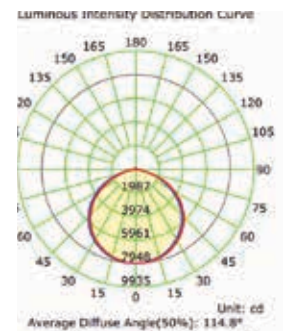
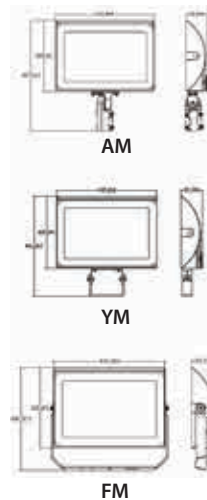

LED KNUCKLE FLOOD LIGHTS

GAS STATIONS / HOSPITALS / FACTORY

OVERVIEW

This LED Flood Light is designed and engineered as maintenance free, energy-contamination of the night sky, while providing highly effective delivered lumens for outdoor illumination at hotels, garages, gas stations, public spaces, schools, universities, hospitals, factory floor, libraries, square, supermarkets, railway stations, advertising lighting, etc.

FEATURES

- ✓ Light is soft and uniform, safe to eyes.
- ✓ Seoul Semiconductor Chip, high CRI.
- ✓ Greenland Eco-friendly without mercury.
- ✓ IP65 driver, input voltage 100-277VAC
- ✓ No UV or IR in the beam
- ✓ China brand IP65 driver
- ✓ 60%~80% Energy Savings

PRODUCT SPECIFICATION

-	30W LED	50W LED
Power Wattage :	30W	50W
Kelvins	5700K	5700K
Lumens	3750LM	6250LM
Efficacy (Lm/Watt)	125LM/W	125LM/W
Input Voltage	100-277V	100-277V
Base Type:	Knuckle	Knuckle
IP Grade	IP65	IP65
Life Span	50,000 Hours	50,000 Hours
Certification	UL/DLC	UL/DLC
Warranty	5 Years	5 Years



LED KNUCKLE FLOOD LIGHTS

GAS STATIONS / HOSPITALS / FACTORY

Photometric/Dimensions

30W

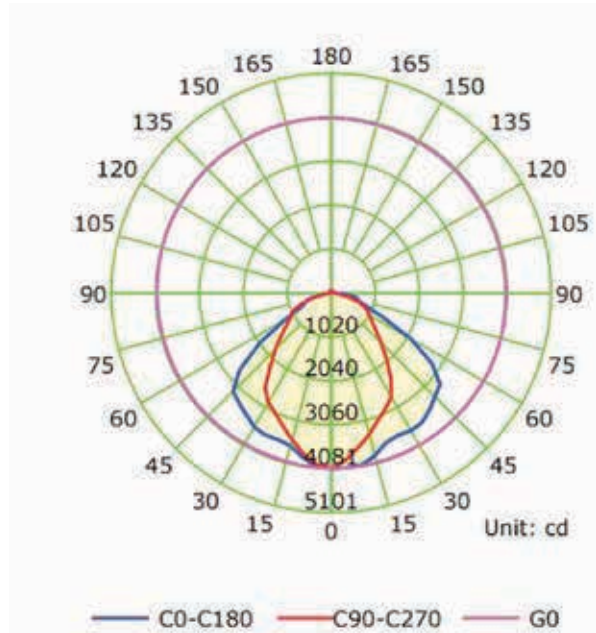
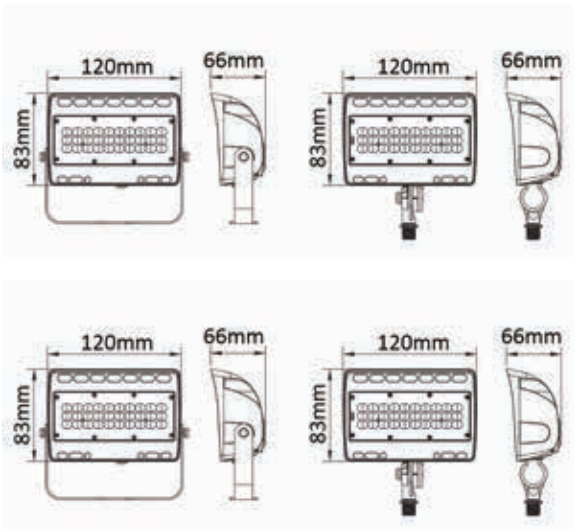

50W

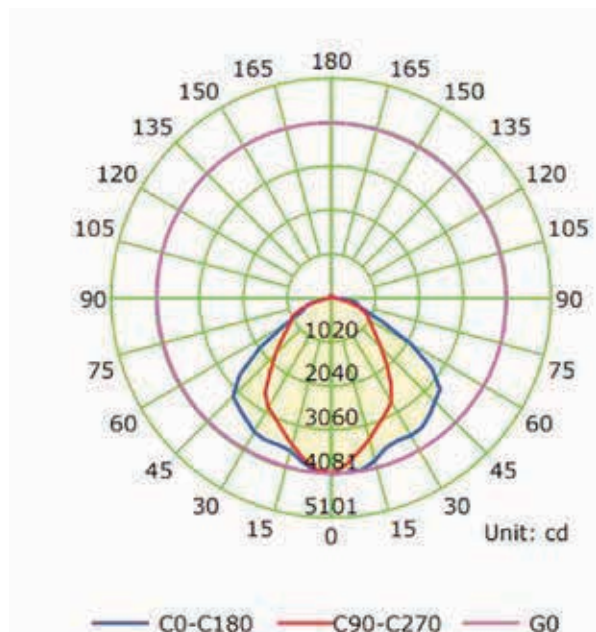
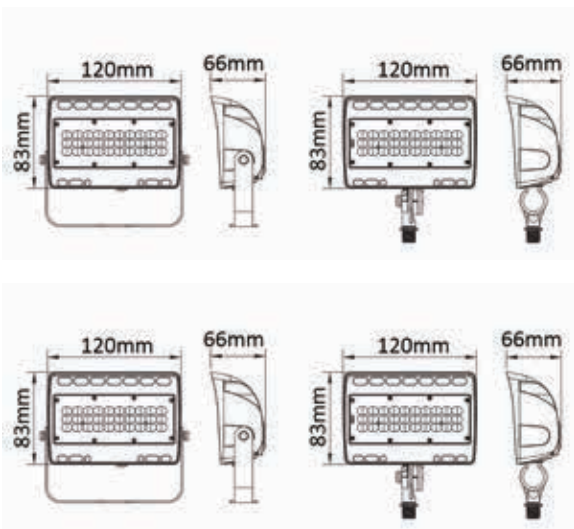



DiscountLED



LED RECESSED/DOWNLIGHTS
KITCHEN / DRAWING ROOM / OFFICES

UL & DLC CERTIFIED

LED RECESSED/DOWNLIGHTS

KITCHEN / DRAWING ROOM / OFFICES

OVERVIEW

The lumen output of this light is 1000LM with long lifespan, and high energy efficiency. Housing is made of aluminum alloy and PC for excellent heat dissipation. This led has 2 clips to make the light stable in hole, very bright and contemporary looking structure with ETL or Energy star approved.



FEATURES

- ✓ ETL Approved.
- ✓ 120VAC.
- ✓ 6" white Trim.
- ✓ Color Temperature Adjustable (3K-5K)
- ✓ Energy saving, long lifespan.
- ✓ Instant On/Off
- ✓ Instant start, NO flickering, NO humming.

PRODUCT SPECIFICATION

-	4" JBOX Downlight	6" JBOX Downlight	8" JBOX Downlight
Watt	10W	15W	30W
Size	4"	6"	8"
Input Voltage:	120V AC	120V AC	120V AC
Lumens	650 LM	975 LM	2250 LM
Kelvins	3000K,4000K,5000K,6000K	3000K,4000K,5000K,6000K	3000K,4000K,5000K,6000K
Dimmable	YES	YES	YES
CRI	>90	>90	>90
Trim Shape	Round/Square	Round/Square	Round/Square
Life	50000 Hours	50000 Hours	50000 Hours
Certification	ETL/Energy Star	ETL/Energy Star	ETL/Energy Star
Warranty	3 Years	3 Years	3 Years

LED RECESSE D/DOWNLIGHTS

KITCHEN / DRAWING ROOM / OFFICES

OVERVIEW

The lumen output of this light is 1000LM with long lifespan, and high energy efficiency. Housing is made of aluminum alloy and PC for excellent heat dissipation. This led has 2 clips to make the light stable in hole, very bright and contemporary looking structure with ETL or Energy star approved.



FEATURES

- ✓ ETL Approved.
- ✓ 120VAC.
- ✓ 6" white Trim.
- ✓ Color Temperature Adjustable (3K-5K)
- ✓ Energy saving, long lifespan.
- ✓ Instant On/Off
- ✓ Instant start, NO flickering, NO humming.



PRODUCT SPECIFICATION

-	4" LED	6" LED
Watt	10W	15W
Size	4"	6"
Input Voltage:	120V AC	120V AC
Lumens	650 LM	975 LM
Kelvins	3000K,4000K,5000K,6000K	3000K,4000K,5000K,6000K
Dimmable	YES	YES
CRI	>90	>90
Trim Shape	Round/Square	Round/Square
Life	50000 Hours	50000 Hours
Certification	ETL/Energy Star	ETL/Energy Star
Warranty	3 Years	3 Years



LED RECESSE D/DOWNLIGHTS JBOX (SEPERATE DRIVER)

KITCHEN / DRAWING ROOM / OFFICES

OVERVIEW

The lumen output of this light is 1000LM with long lifespan, and high energy efficiency. Housing is made of aluminum alloy and PC for excellent heat dissipation. This led has 2 clips to make the light stable in hole , very bright and contemporary looking structure with ETL or Energy star approved.

FEATURES

- ✓ ETL Approved.
- ✓ 120VAC.
- ✓ 6" white Trim.
- ✓ Color Temperature Adjustable (3K-5K)
- ✓ Energy saving, long lifespan.
- ✓ Instant On/Off
- ✓ Instant start, NO flickering, NO humming.

PRODUCT SPECIFICATION

-	4" JBOX (Seperate Driver)	6" JBOX (Seperate Driver)
Watt	10W	15W
Size	4"	6"
Input Voltage:	120V AC	120V AC
Lumens	650 LM	1000 LM
Kelvins	3000K,4000K,5000K,6000K	3000K,4000K,5000K,6000K
Dimmable	YES	YES
CRI	>90	>90
Trim Shape	Round	Round
Life	50000 Hours	50000 Hours
Certification	ETL/Energy Star	ETL/Energy Star
Warranty	3 Years	3 Years



DiscountLED

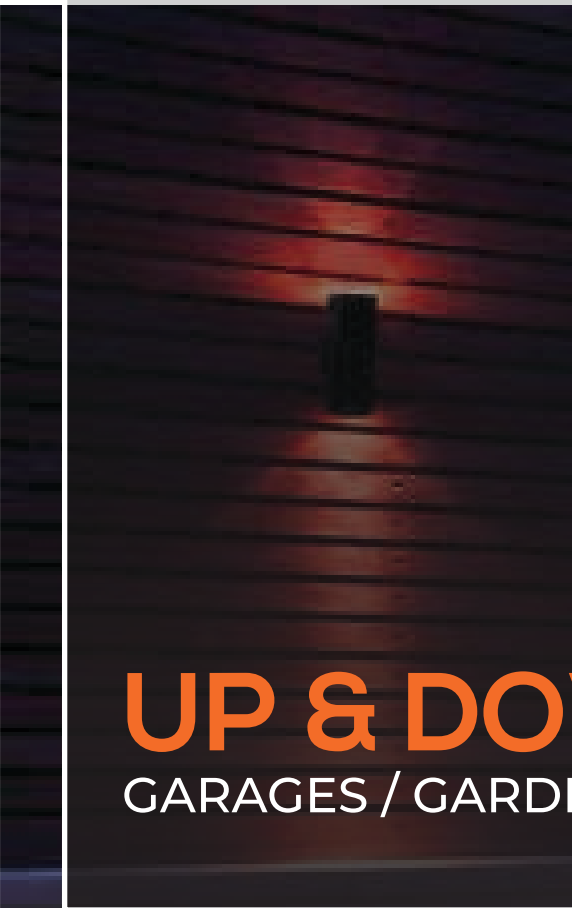

UP & DOWN WALLPACK

GARAGES / GARDENS / CORRIDORS

UL & DLC CERTIFIED



UP & DOWN WALLPACK

GARAGES, GARDENS, CORRIDORS

OVERVIEW

Up & Down Wallpack is designed for longevity in any outdoor environment, our Wall Packs boasts products that are IP-Rated, Dark Sky Friendly, and our Wall packs designed with durability and quality in mind

FEATURES

- ✓ ETL certified.
- ✓ Easy to install and operate.
- ✓ IP66 driver, input voltage 100-277VAC.
- ✓ Energy-saving, long lifespan.
- ✓ Instant On/Off
- ✓ Light is soft and uniform, safe to eyes.
- ✓ Aluminum body, Glass Cover, Aluminum Heat Sink



PRODUCT SPECIFICATION

-	48W (2x24W) Up & Down
Power Wattage :	48W (2x24W)
Input Voltage	100-277V ac 50HZ/60HZ
Beam Angle	15°/30°/60°
LED Color	Red/Green/Blue/CW/WW/RGB
Housing Color	Brown/Black/Gray
IP Grade	IP66
Certification	ETL
Height Coverergae	50 FT
Warranty	5 Year



DiscountLED

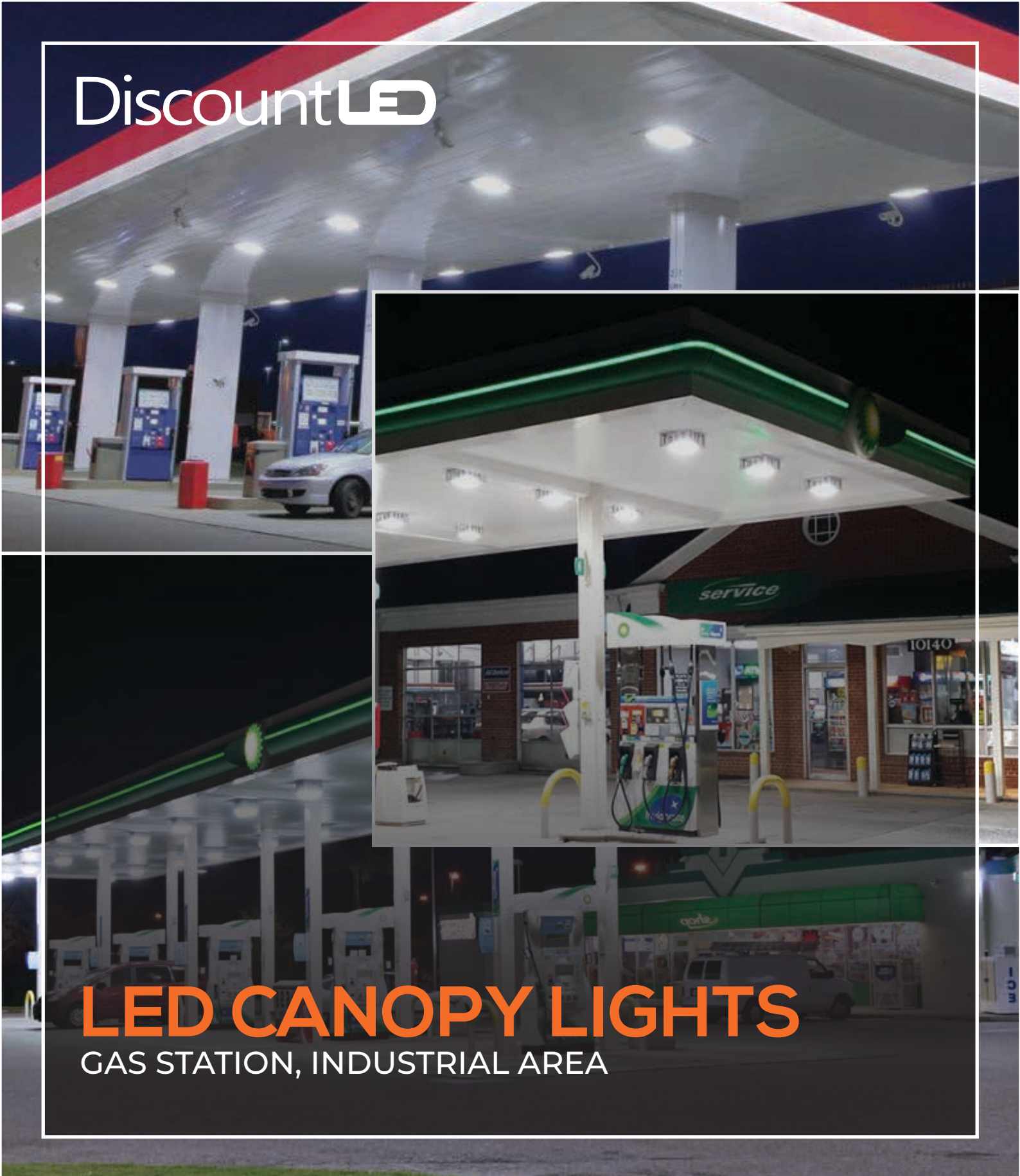

LED CANOPY LIGHTS

GAS STATION, INDUSTRIAL AREA

UL & DLC CERTIFIED



LED CANOPY LIGHTS

GAS STATION, INDUSTRIAL AREA

OVERVIEW

These Outdoor LED Canopy Light are specially manufactured to cover the large areas and it can be widely used in Gas stations, industrial areas, residential areas, Outdoor Canopies , & high ceiling.



FEATURES

- ✓ UL DLC certified
- ✓ IP65 driver, input voltage 100-277VAC
- ✓ No UV or IR in the beam
- ✓ Easy to install and operate
- ✓ Light is soft and uniform, safe to eyes.
- ✓ Instant start, NO flickering, NO humming.
- ✓ Green and eco-friendly without mercury.
- ✓ 60%~80% Energy Savings



PRODUCT SPECIFICATION

-	55W LED	150W LED	150W LED FLAT
SKU	DL-55W	DL-150W	DL-150W
Power Wattage :	55W	150W	150W
Kelvins	5700K	5700K	5700K
Lumens	6875LM	18750LM	18750LM
Efficacy (Lm/Watt)	125LM/W	125LM/W	125LM/W
Input Voltage	100-277V	100-277V	100-277V
IP Grade	IP65	IP65	IP65
Life Span	50,000 Hours	50,000 Hours	50,000 Hours
Certification	UL/DLC	UL/DLC	UL/DLC
Warranty	5 Years	5 Years	5 Years

LED CANOPY LIGHTS

GAS STATION, INDUSTRIAL AREA

Photometric/Dimensions

55W LED

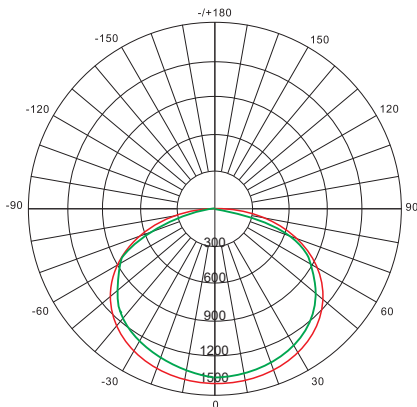
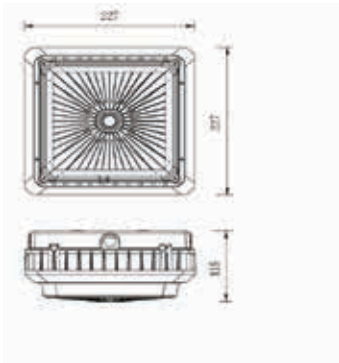

150W LED

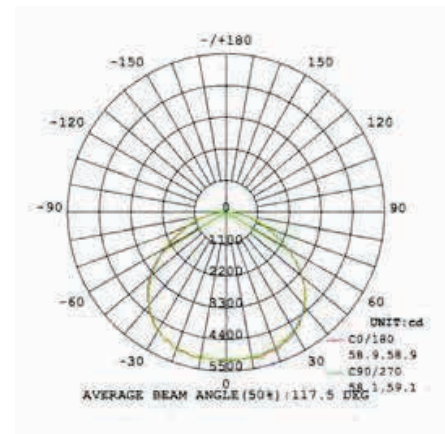
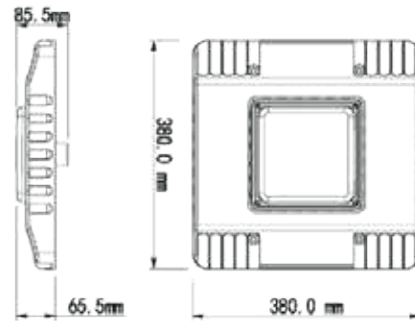

150W LED FLAT

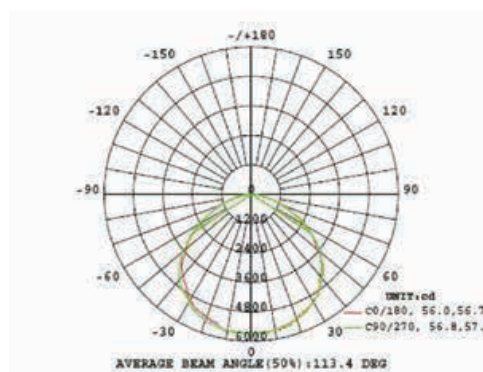
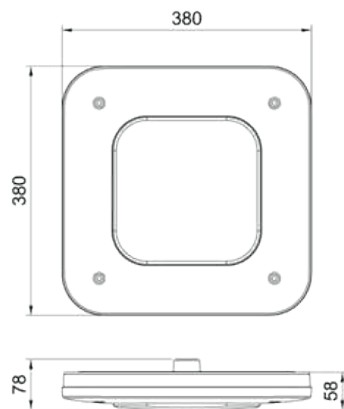

DiscountLED

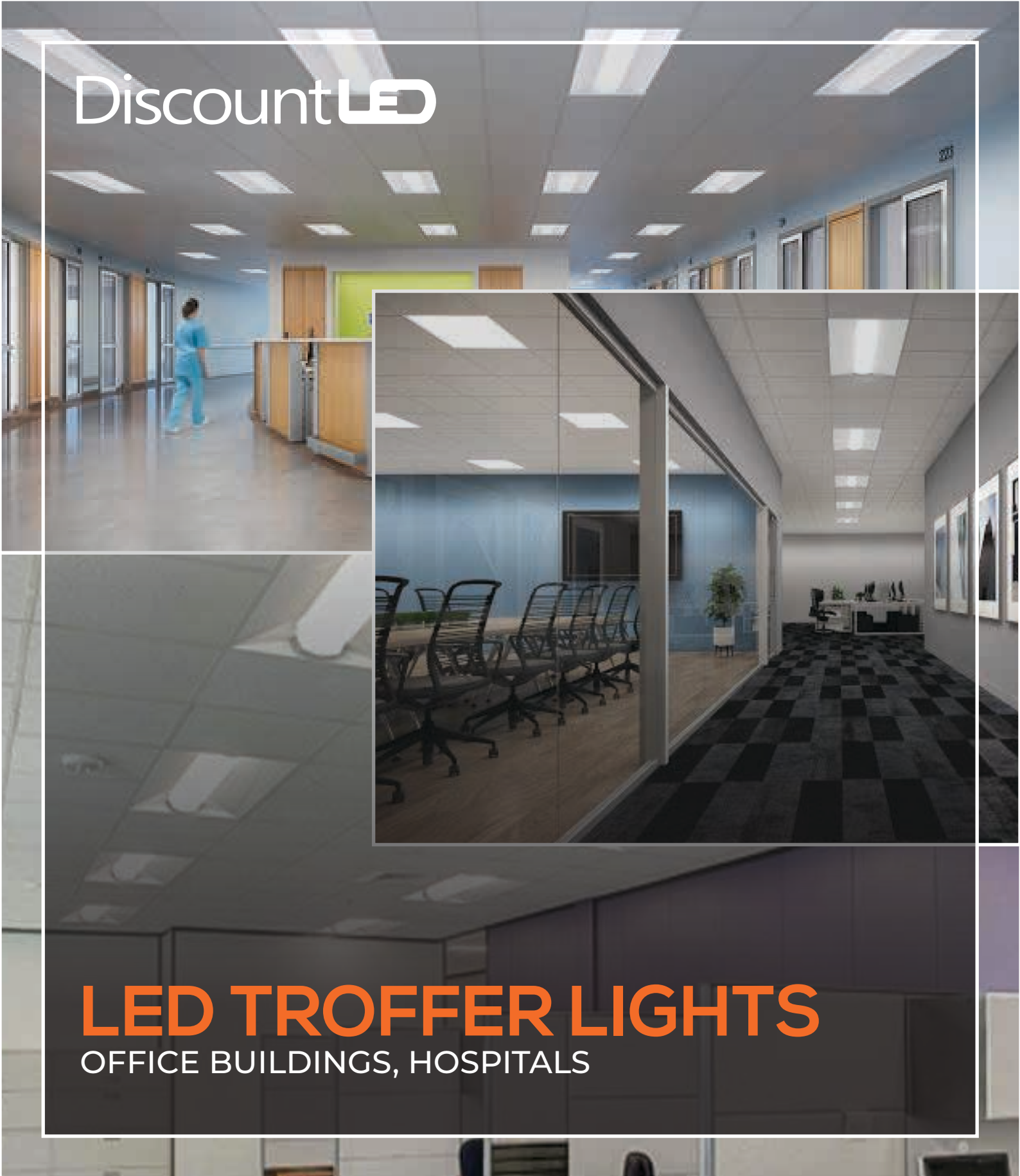

LED TROFFER LIGHTS

OFFICE BUILDINGS, HOSPITALS

UL & DLC CERTIFIED

LED TROFFER LIGHTS

OFFICE BUILDINGS, HOSPITALS

OVERVIEW

These Ceiling Troffers are at the cutting-edge of modern design and are hazardous material-free and maintenance-free. Easy installation for recessed, suspended, or surface mounted. This fixture can be used in office buildings, hospitals, schools, kitchens and more.



PRODUCT SPECIFICATION

-	2x2 LED Panel Troffer-5000K	2x4 LED Panel Troffer-5000K
Watt	40W	60W
Size	2'x2'	2'x4'
Input Voltage:	AC 100-277Vac	AC 100-277Vac
Lumens	5000 LM	7500 LM
Kelvins	5000K	5000K
Dimmable	YES	YES
CRI	>80	>80
THD	<10%	<10%
IP Rating	IP40	IP40
Beam Angle	120°	120°
Certification	ETL/DLC	ETL/DLC
Warranty	5 Years	5 Years

LED TROFFER LIGHTS

OFFICE BUILDINGS, HOSPITALS

Photometric/Dimensions

2x2 LED Panel Troffer-5000K

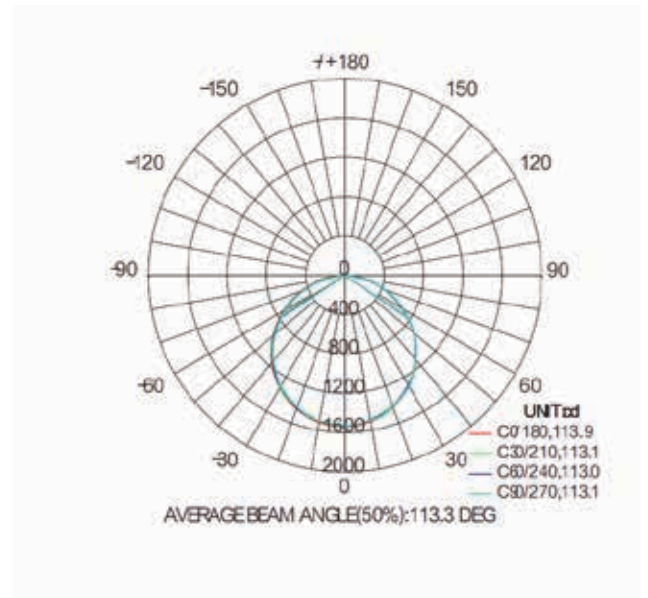
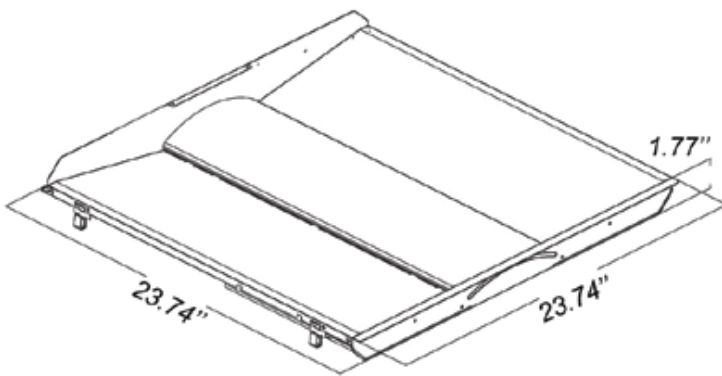

2x4 LED Panel Troffer-5000K

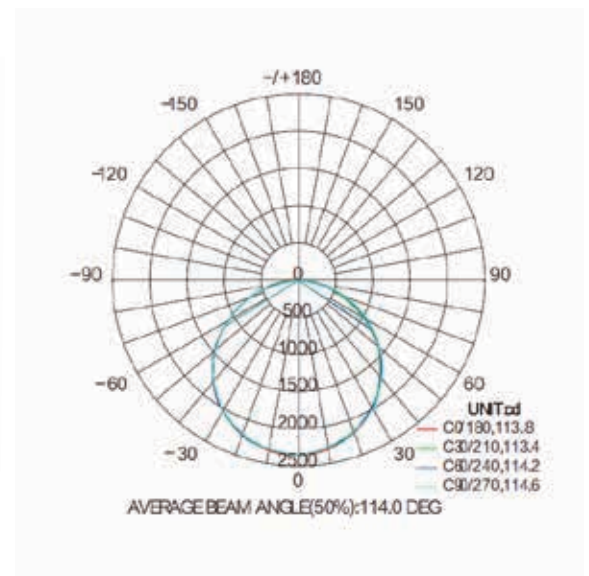
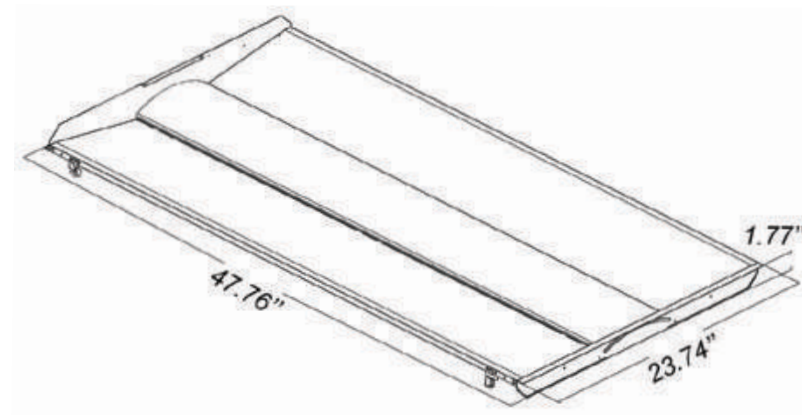

DiscountLED

LED PANEL LIGHTS

COMMERCIAL BUILDING, SCHOOLS & OFFICES

UL & DLC CERTIFIED



LED PANEL LIGHTS

COMMERCIAL BUILDING, SCHOOLS & OFFICES

OVERVIEW

These Led Panel were designed and engineered as maintenance free, energy-contamination of the night sky, while providing highly effective delivered lumens for indoor illumination at hotels, garages, commercial buildings, public spaces, schools, universities, and hospitals.



PRODUCT SPECIFICATION

-	2x2 LED Panel Light-6500K	2x4 LED Panel Light-6500K
Watt	40W	72W
Size	2'x2'	2'x4'
Input Voltage:	AC 100-277Vac	AC 100-277Vac
Lumens	5000 LM	9000 LM
Kelvins	6500K	6500K
Dimmable	YES	YES
CRI	>80	>80
THD	<10%	<10%
IP Rating	IP40	IP40
Beam Angle	120°	120°
Certification	ETL	ETL
Warranty	3 Years	3 Years

LED PANEL LIGHTS

COMMERCIAL BUILDING, SCHOOLS & OFFICES

Photometric/Dimensions

2x2 LED Panel-6500K

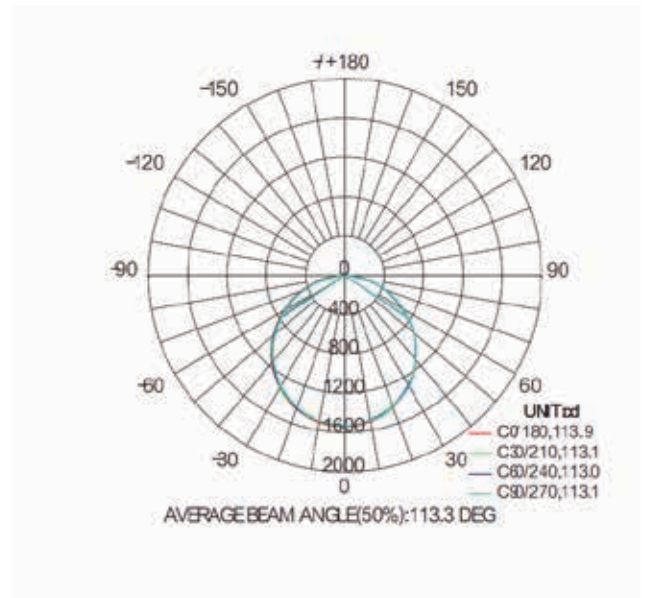
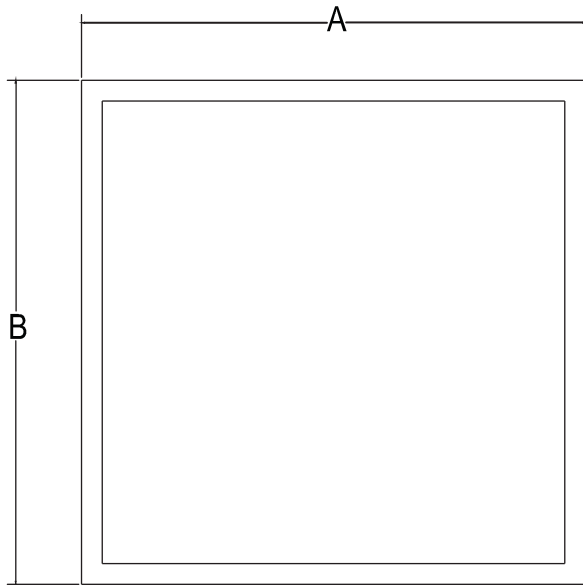

2x4 LED Panel-6500K

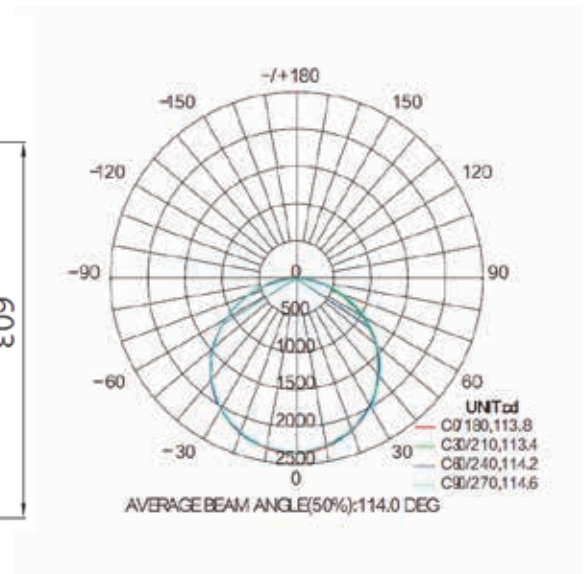
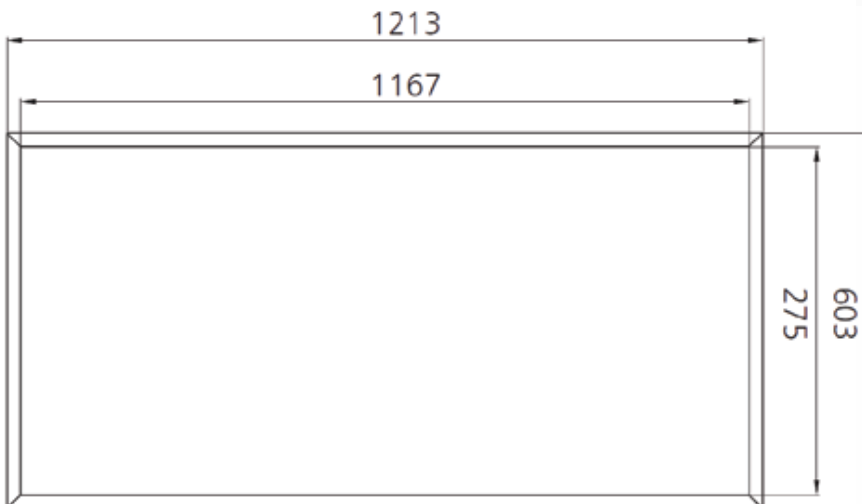

LED PANEL LIGHTS

COMMERCIAL BUILDING, SCHOOLS & OFFICES

OVERVIEW

These Led Panel were designed and engineered as maintenance free, energy-contamination of the night sky, while providing highly effective delivered lumens for indoor illumination at hotels, garages, commercial buildings, public spaces, schools, universities, and hospitals.



PRODUCT SPECIFICATION

-	2x2 LED Panel Light- CCT	2x4 LED Panel Light- CCT
Watt	20W/30W/40W	40W/50W/60W
Size	2'x2'	2'x4'
Input Voltage:	AC 100-277Vac	AC 100-277Vac
Lumens	2500-5000 LM	5000-7500 LM
Kelvins	3000K/4000K/5000K CCT	3000K/4000K/5000K CCT
Dimmable	YES	YES
CRI	>80	>80
THD	<10%	<10%
IP Rating	IP40	IP40
Beam Angle	120°	120°
Certification	ETL/DLC	ETL/DLC
Warranty	3 Years	3 Years

LED PANEL LIGHTS

COMMERCIAL BUILDING, SCHOOLS & OFFICES

Photometric/Dimensions

2x2 LED Panel-3 CCT

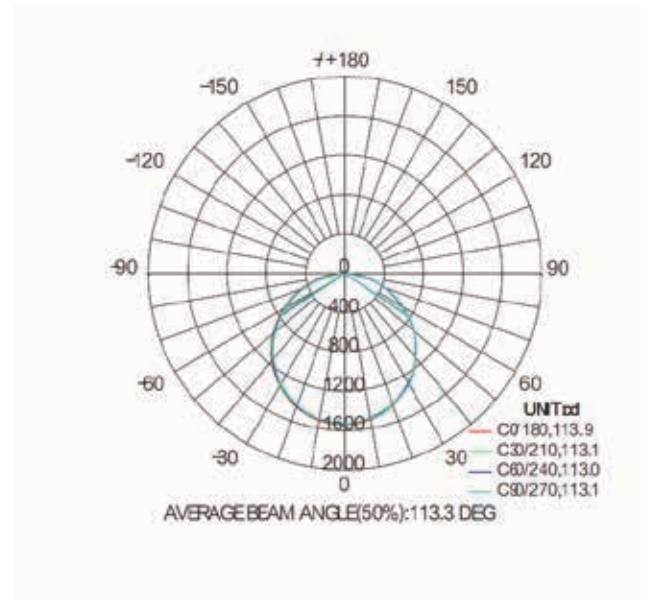
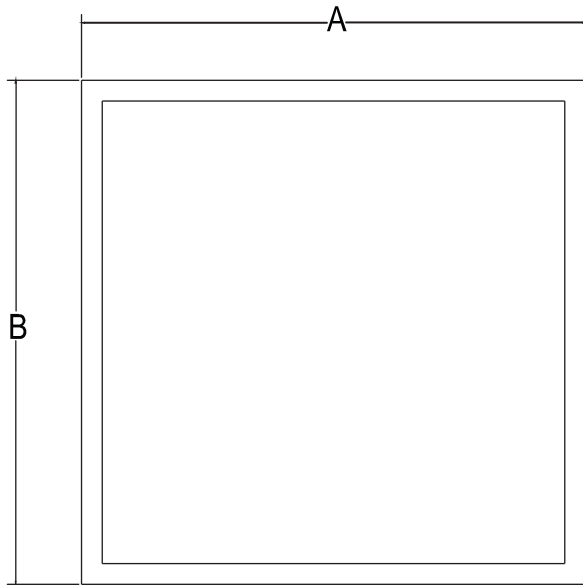

2x4 LED Panel-3 CCT

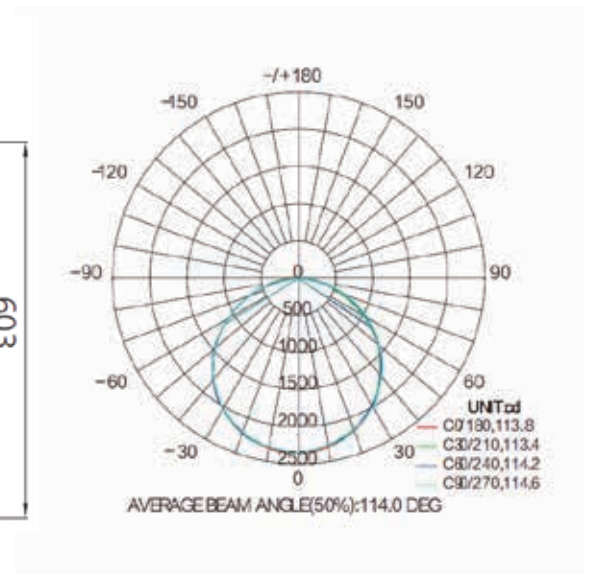
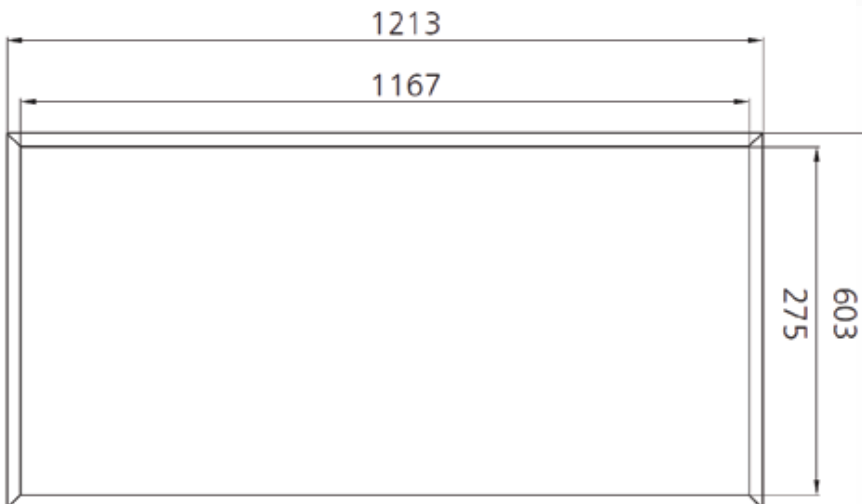



DiscountLED



LED BULBS

KITCHEN / DRAWING ROOM / OFFICES

UL & DLC CERTIFIED

A19 & A21 LED BULB

KITCHEN / DRAWING ROOM / OFFICES

OVERVIEW

The lumen output of this A19 bulb is 750LM ,Available in 3000K & 5000K Equivalent to 60W incandescent bulb which means it saves around 85% in electricity bill , its a E26/E27 base ,UL certified with 1 Year of warranty.



PRODUCT SPECIFICATION

-	A19 9W LED Bulb	A19 9W GU24 LED Bulb
Specification	A19 9W LED Bulb	A19 9W GU24 LED Bulb
Watt	9W	9W
Bulb Size	A19	A19
Input Voltage:	120V AC	120V AC
Lumens	750 LM	750 LM
Kelvins	3000K & 5000K	3000K & 5000K
Dimmable	YES	YES
CRI	>80	>80
Base Type	E26/E27	GU24
Life	30000 Hours	30000 Hours
Certification	UL	UL
Warranty	1 Year	1 Year

PAR LED BULBS

KITCHEN / DRAWING ROOM / OFFICES

OVERVIEW

PAR (short for Parabolic Aluminized Reflector) bulbs are lamps with "spot light" features, meaning that they provide a beam spread that is typically lower than 45°. Use PAR bulbs when attempting to put a focused beam of light on an object such as in track lighting or illuminating artwork.



PRODUCT SPECIFICATION

-	PAR20 10W	PAR30 12W	PAR38 20W
Specification	PAR20 10W LED Light Bulb	PAR30 12W LED Light Bulb	PAR38 20W LED Light Bulb
Watt	8W	12W	20W
Bulb Size	PAR20	PAR30	PAR38
Input Voltage:	120V AC	120V AC	120V AC
Lumens	608 LM	840 LM	1675 LM
Kelvins	3000K & 5000K & 6000K	3000K & 5000K & 6000K	3000K & 5000K & 6000K
Dimmable	NO	NO	NO
CRI	>83	>83	>83
Base Type	E26/E27	E26/E27	E26/E27
Life	30000 Hours	30000 Hours	30000 Hours
Certification	Energy Star	Energy Star	Energy Star
Warranty	1 Year	1 Year	1 Year

BR LED BULBS

KITCHEN / DRAWING ROOM / OFFICES

OVERVIEW

Super Tech LEDS BR40 17W is a replacement of 95W MH bulb and gives out around 1400 Lumens of brightness and also available in 3000K 4000K & 5000K ETL or Energy star listed with 1 year of warranty.



PRODUCT SPECIFICATION

-	BR30 10W	BR40 20W
Specification	BR30 10W LED Light Bulb	BR40 20W LED Light Bulb
Watt	10W	20W
Bulb Size	BR30	BR40
Input Voltage:	120V AC	120V AC
Lumens	750 LM	750 LM
Kelvins	3000K & 5000K	3000K & 5000K
Dimmable	YES	YES
CRI	>80	>80
Base Type	E26/E27	GU24
Life	30000 Hours	30000 Hours
Certification	UL	UL
Warranty	1 Year	1 Year

GU10 AND MR16 BULBS

GALLERY / DECORATION / OFFICES

OVERVIEW

Super Tech LEDS GU10 and the MR16 are the main two spotlights used in the home today. ... The main difference is that the GU10 bulb will run at 240 volts (which is the same voltage as supplied by the mains power supply), while MR16 bulbs run on just 12 volts.



PRODUCT SPECIFICATION

-	GU10 5W	MR16 12V 5W
Specification	GU10 5W LED BULB	MR16 12V 5W LED BULB
Watt	5W	12W
Bulb Size	GU10	PAR30
Input Voltage:	100-240V	120V AC
Lumens	400 LMS	840 LM
Kelvins	3000K & 5000K	3000K & 5000K & 6000K
Dimmable	NO	NO
Beam Angle	60 Degrees	>83
Base Type	GU10	E26/E27
Life	30000 Hours	30000 Hours
Certification	UL	Energy Star
Warranty	1 Year	1 Year

DiscountLED

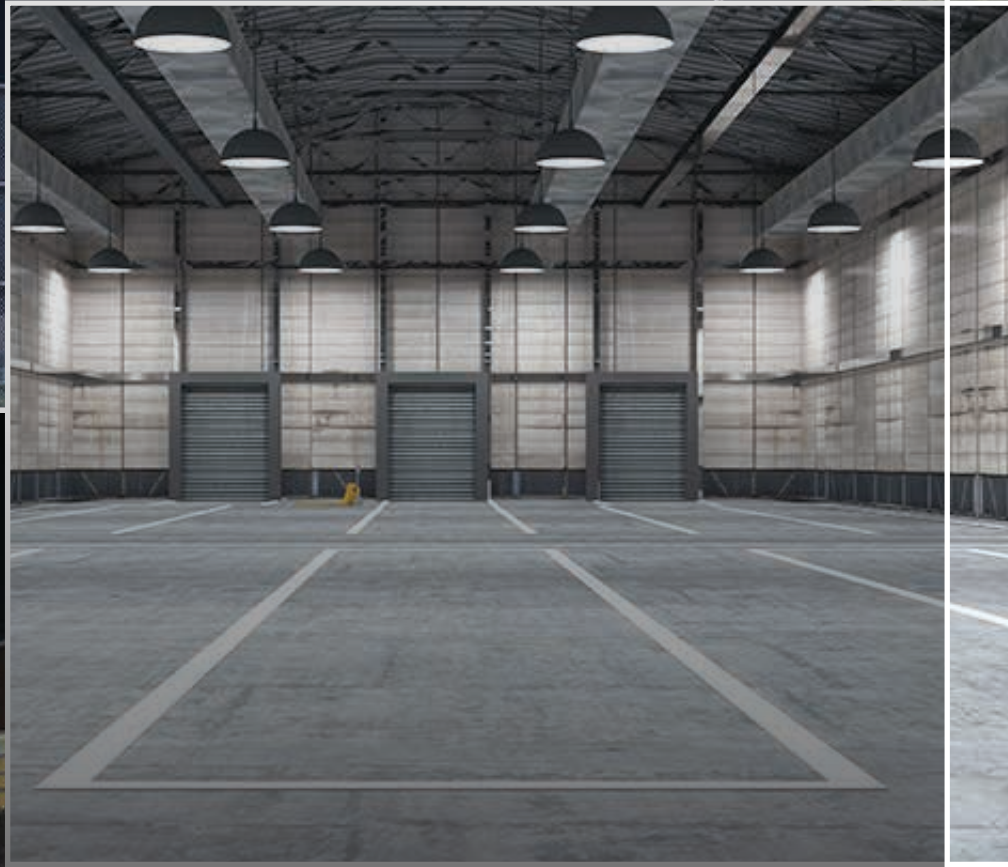

LED CORNCOB BULB

OFFICE, BUILDINGS, HOSPITALS

UL & DLC CERTIFIED

LED CORNCOB BLUB S

OFFICE, BUILDINGS, HOSPITALS

OVERVIEW

Use this LED corn light bulb to easily convert metal-halide (MH) and other high-intensity discharge (HID) fixtures into long-lasting, energy-efficient LED fixtures.

FEATURES

- ✓ Input Voltage: 100-277V AC, 50-60 Hz
- ✓ Operating Temperature: -20 °C to 45°C
- ✓ Operating Humidity: 20% -70% RH
- ✓ Storage Temperature: -30 °C to 80°C
- ✓ Waterproof Rating: IP64
- ✓ Warranty: 5 Years



PRODUCT SPECIFICATION

-	30W	40W	60W	80W
Watt	30W	40W	60W	80W
Lumens:	3200-3400lm	4300-4600 lm	6200-6600 lm	8800-9400 lm
CCT:	5700K	5700K	5700K	5700K
Power Factor:	>0.9	>0.9	>0.9	>0.9
Efficacy:	105-112 lm/W	107-115 lm/W	105-110 lm/W	110-116 lm/W
Equivalent:	60W CFL, 100W MHL/HPS/HID	80W CFL, 150W MHL/HPS/HID	120W CFL, 175W MHL/HPS/HID	150W CFL, 250W MHL/HPS/HID
CRI:	>80 Ra	>80 Ra	>80 Ra	>80 Ra
Dimensions:	(93*230) mm (E39)	(93*260) mm (E39)	(93*285) mm (E39)	(125*270) mm (E39)
Beam Angle:	360°	360°	360°	360°
Base:	E39	E39	E39	E39
Application:	Indoor/Outdoor	Indoor/Outdoor	Indoor/Outdoor	Indoor/Outdoor

LED CORNCOB BLUB S

OFFICE, BUILDINGS, HOSPITALS

Photometric/Dimensions

30 W

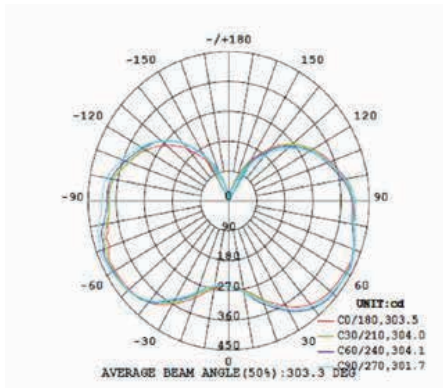
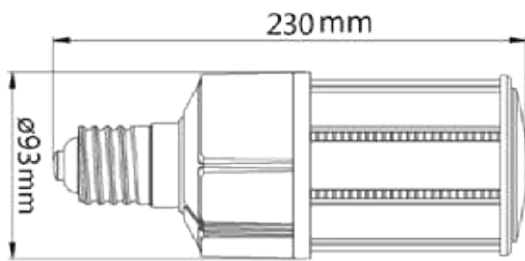

40 W

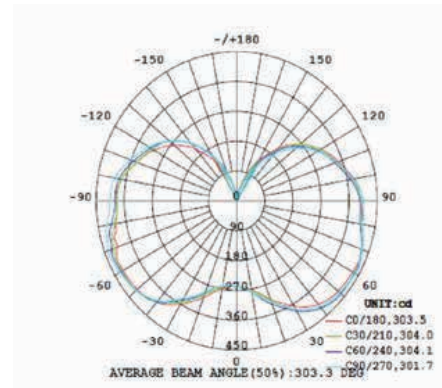
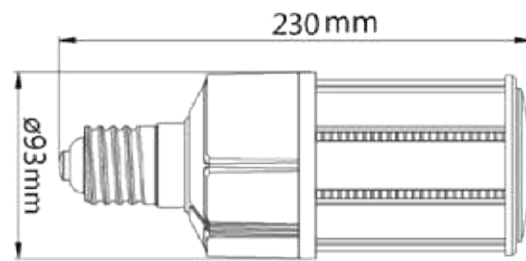

60 W

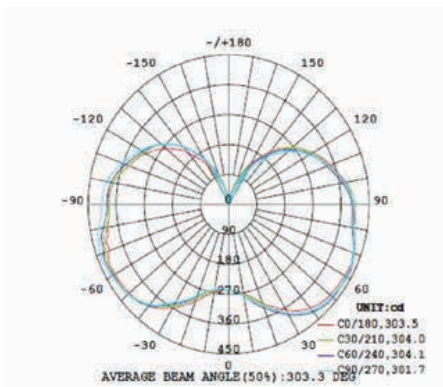
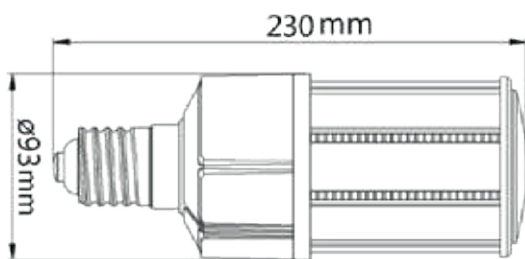

80 W

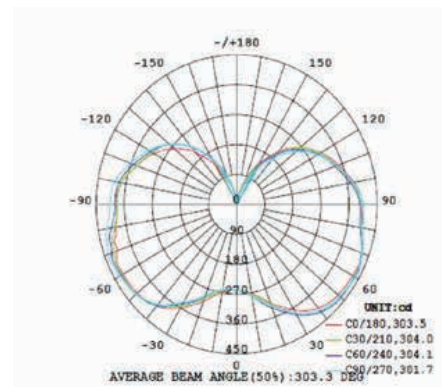
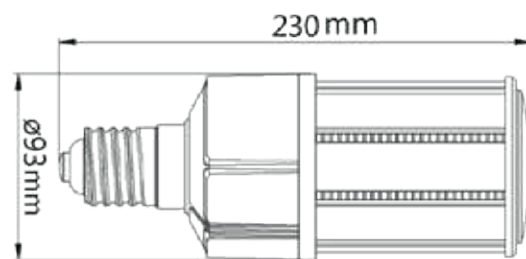

LED CORNCOB BLUB S

OFFICE, BUILDINGS, HOSPITALS

OVERVIEW

Use this LED corn light bulb to easily convert metal-halide (MH) and other high-intensity discharge (HID) fixtures into long-lasting, energy-efficient LED fixtures.

FEATURES

- ✓ Input Voltage: 100-277V AC, 50-60 Hz
- ✓ Operating Temperature: -20 °C to 45°C
- ✓ Operating Humidity: 20% -70% RH
- ✓ Storage Temperature: -30 °C to 80°C
- ✓ Waterproof Rating: IP64
- ✓ Warranty: 5 Years



PRODUCT SPECIFICATION

	100W	120W	150W
Watt	100W	120W	150W
Lumens:	11000-11600 lm	12600-13500 lm	16500-17400 lm
CCT:	5700K	5700K	5700K
Power Factor:	>0.9	>0.9	>0.9
Efficacy:	110-116 lm/W	105-112 lm/W	110-116 lm/W
Equivalent:	200W CFL, 250W MHL/HPS/HID	200W CFL, 400W MHL/HPS/HID	400W MHL/HPS/HID
CRI:	>80 Ra	>80 Ra	>80 Ra
Dimensions:	(125*290) mm (E39)	(125*310) mm (E39)	(125*335) mm (E39)
Beam Angle:	360°	360°	360°
Base:	E39	E39	E39
Application:	Indoor/Outdoor	Indoor/Outdoor	Indoor/Outdoor

LED CORNCOB BLUB S

OFFICE, BUILDINGS, HOSPITALS

Photometric/Dimensions

100 W

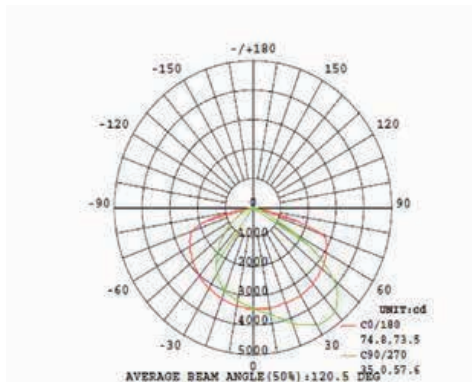
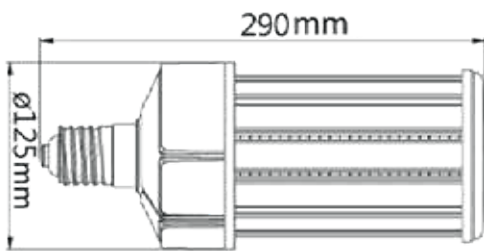

120 W

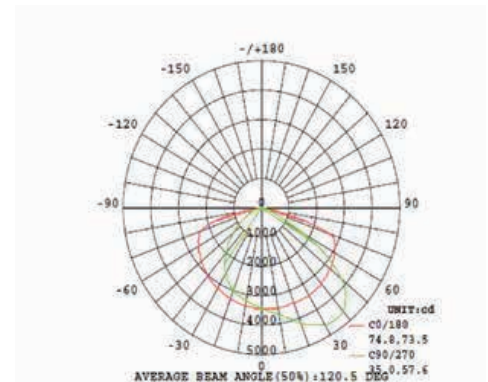
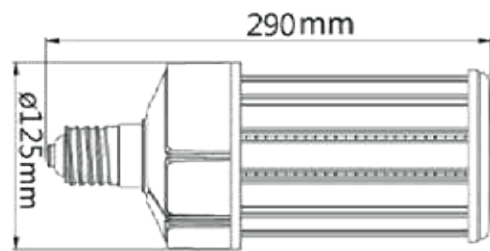

150 W

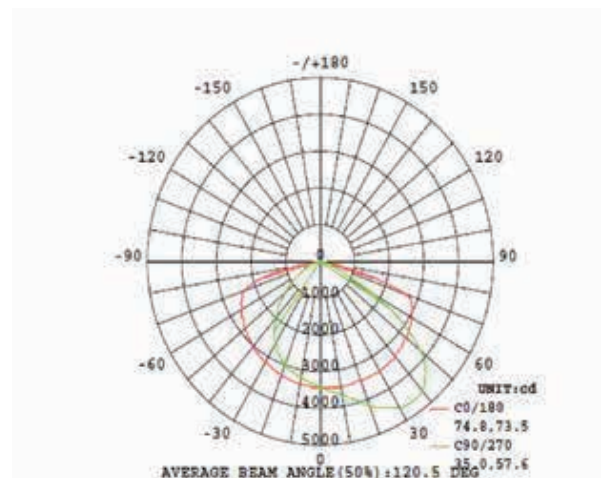
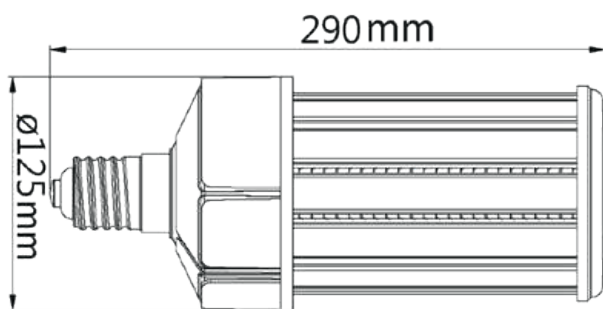

DiscountLED



LED BOLLARDS
GARDEN / BACKYARD / FOOTPATH

UL & DLC CERTIFIED



LED BOLLARDS

GARDEN / BACKYARD / FOOTPATH

OVERVIEW

A short post designed to either identify or mark a location is known as a bollard. These signs are used to guide traffic or protect sensitive areas. Bollards provide effective and efficient visual barriers for both pedestrian and vehicular traffic.



PRODUCT SPECIFICATION

-	2x2 LED Panel Light-CC T	2x4 LED Panel Light- CCT	1x4 LED Panel Light-CCT
Specification	FLAT HEAD BOLLARD 20W	FLAT HEAD BOLLARD 10W	FLAT HEAD BOLLARD 10W
Size	7" L x 7" W x 41" H	7" L x 7" W x 41" H	7" L x 7" W x 41" H
Watts	20W	10W	10W
Lumens	1400 LMS	800 LMS	800 LMS
Kelvins	3000K + 4000K +5000K	3000K + 4000K +5000K	3000K + 4000K +5000K
Voltage	AC100-277	AC100-277	AC100-277
Dimmable	NO	NO	NO
Beam Angle	360 DEGREES	360 DEGREES	360 DEGREES
CRI	>70	>80	>80
PF	>0.9	>0.5	>0.5
IP Rate	IP65	IP65	IP65
Material	ALUMINIUM PC	ALUMINIUM PC	ALUMINIUM PC
Housing Color	BRONZE	BRONZE, BLACK	BRONZE, BLACK
Lifespan	50,000 HOURS	30,000 HOURS	30,000 HOURS



DiscountLED



LED GROW LIGHTS

GROW WAREHOUSE

UL & DLC CERTIFIED



LED GROW LIGHTS

GROW WAREHOUSE

OVERVIEW

GROW LIGHT provide a bright and flexible rack lighting solution to maximizes the grow space and better quality, create the most advanced spectrum for plant growth, Whether growing cannabis, food or ornamental plants, the grow light was designed for single or multi-tier growers who want to optimize their grow space for the maximum crop yield while producing the highest quality crops

FEATURES

- ✓ Full spectrum with enhanced red for full grows.
- ✓ Easy to install, just plug and play
- ✓ Using UL certified drive;
- ✓ Efficacy is up to 3.0 umol/J.
- ✓ Using Samsung LM301b & Osram LED Chip



PRODUCT SPECIFICATION

-	660W	720W
Input Power	660W	720W
Weight	24lbs/10kg	26.46lbs/12kg
Spectrum	V1 F1 E1 T1 (DefaultV1)	
AC Input Voltage	120-277V AC, 347-480V AC, 50/60Hz	
Mounting Height	≥ 6"(15.2cm) Above Canopy	
Viewing Angle	130°	
Thermal Management	Passive	
Max. Ambient Temperature	90°F/35°C	
Dimming	0-10V Dimmable	
Total Harmonic Distortion	<15%	
Warranty	5 years	

LED GROW LIGHTS

GROW WAREHOUSE

Photometric/Dimensions

660 W

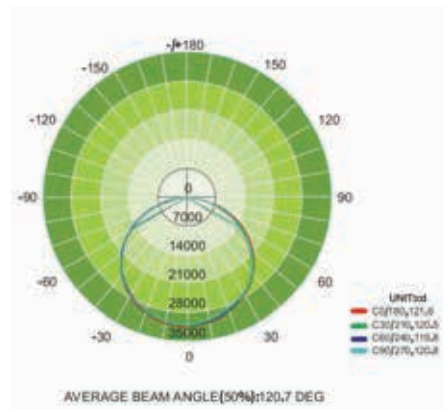
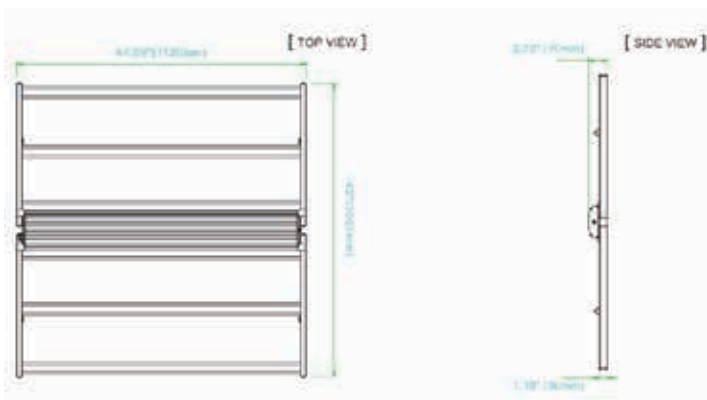

720 W

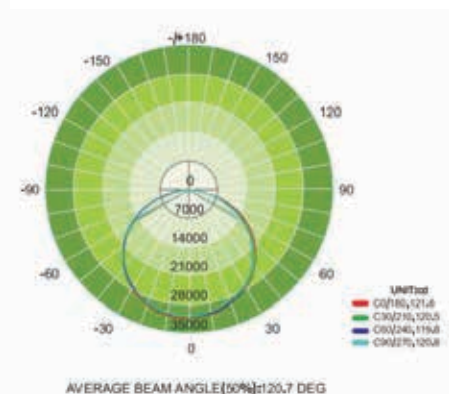
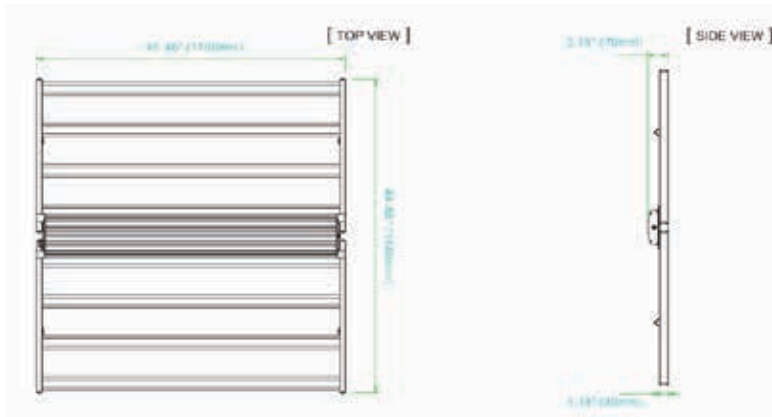

DiscountLED



LED PARCKING GARAGE LIGHT

PARKING & GARAGE

UL & DLC CERTIFIED



LED PACKING GARAGE LIGHT

PARKING & GARAGE

OVERVIEW

Widely used in underground parking lot, garage and so on..

FEATURES

- ✓ UL DLC certified
- ✓ IP65 driver,input voltage 120-277VAC
- ✓ No UV or IR in the beam
- ✓ Easy to install and operate
- ✓ Light is soft and uniform, safe to eyes.
- ✓ Instant start, NO flickering, NO humming.
- ✓ Green and eco-friendly without mercury.
- ✓ Energy Saving, long lifespan



PRODUCT SPECIFICATION

-	55W LED
SKU	DL-55W
Power Wattage :	55W
Kelvins	5700K
Lumens	7054LM
Efficacy (Lm/Watt)	134LM/W
Input Voltage	120-277V
IP Grade	IP65
Life Span	50,000 Hours
Certification	UL/DLC
Warranty	5 Years

LED PACKING GARAGE LIGHT

PARKING & GARAGE

Photometric/Dimensions

55W LED

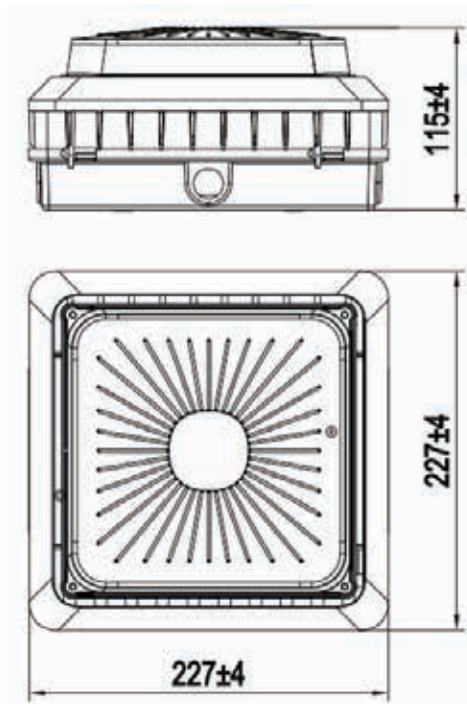

Luminous Intensity Distribution Curve

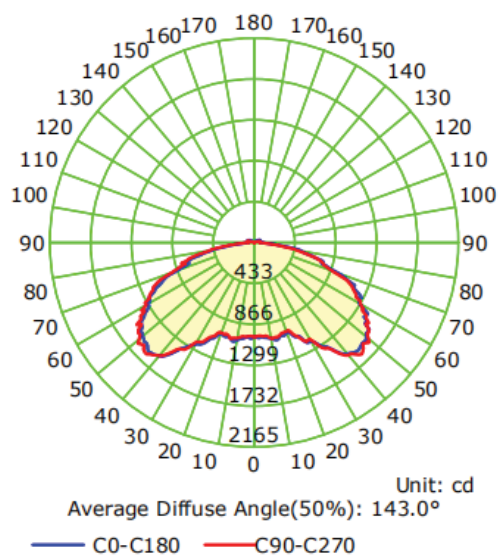

DiscountLED

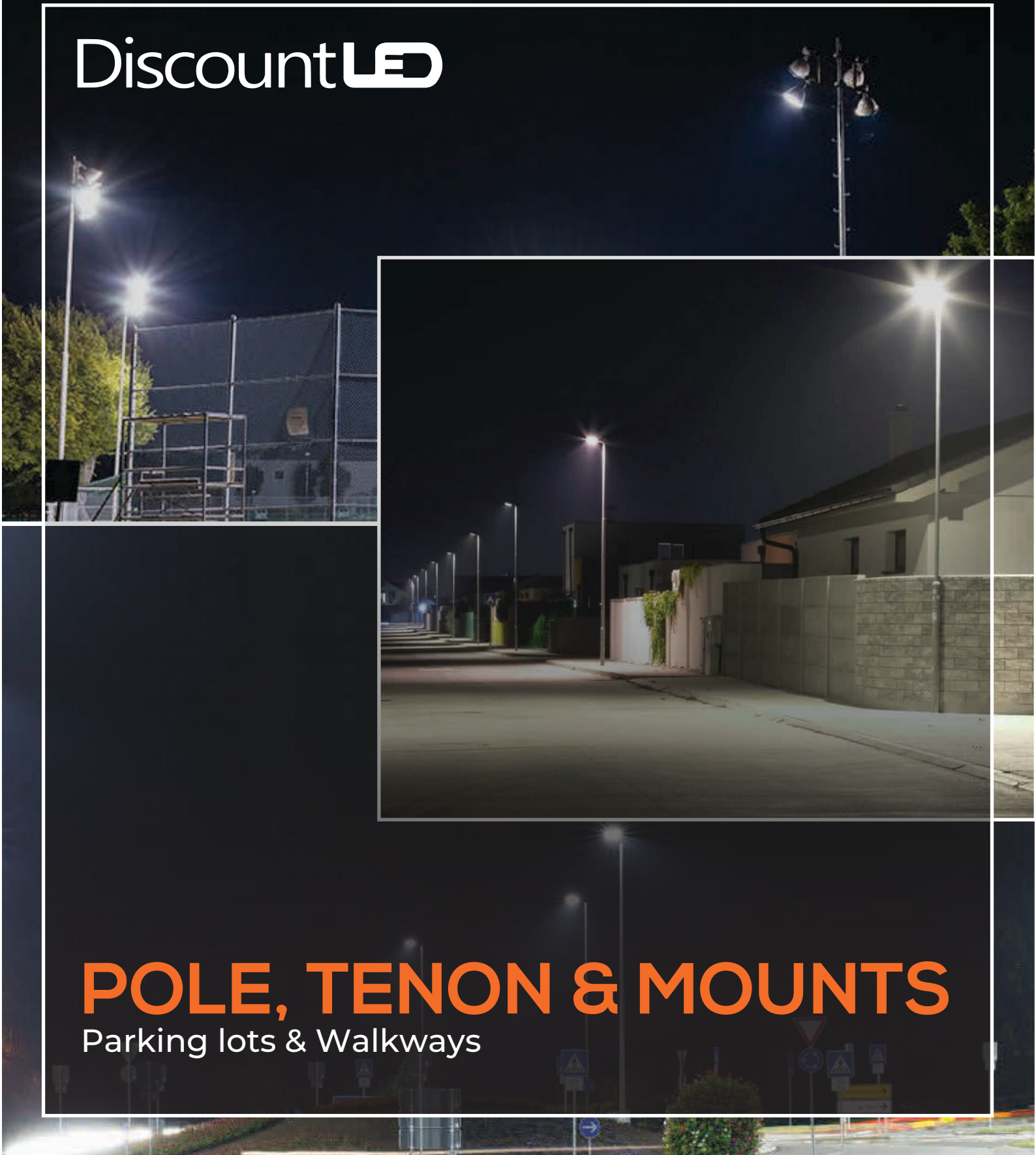

POLE, TENON & MOUNTS

Parking lots & Walkways

UL & DLC CERTIFIED

POLE, TENON & MOUNTS

PARKING LOTS & WALKWAYS

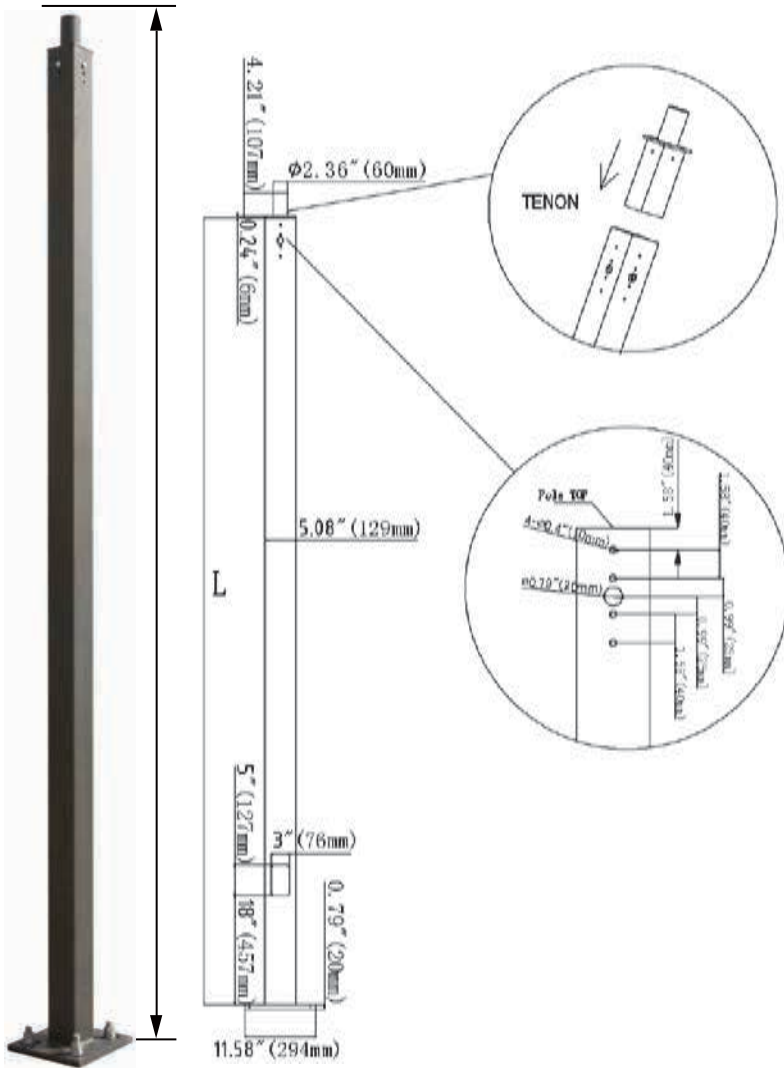

The 1000LED Series Straight Square Steel poles are built from high strength steel tube and are available side drilled for arm mounted area lighting luminaires or with tenon mounts for flood and post top luminaires. Typical area lighting applications include retail centers, industrial parks, schools and universities, public transit and airports, office buildings and medical facilities. Mounting heights of 10 to 30 feet can be used based on selected luminaire application.

Specifications and Features: Pole

Specifications:

Conforms to ASTM-A 500 Grade B: Minimum Yield Strength of 46,000 PSI.

Finish:

Textured Architectural Bronze Powdercoat Finish, Baked to Ensure Maximum Paint Adhesion, Hardness and Durability.

Anchor Bolts:

Anchor Bolts are Included, Sized Based on Pole Data Charts for the Selected Pole Size.

Hand Hole:

Cast Iron Reinforced Hand Hole and Cover with Ground Screw.

Base Cover:

Poles are Provided With a Two-Piece Formed Steel Base Cover that is Easily Assembled and Fitted Over Pole Base.

Pole Length:

Poles are Available in Standard Lengths as Shown in the Order Matrix. Poles can be Custom Cut to Order. Consult Factory.

Mounting Options:

Standard Length Poles Include 2½" OD Tenon, Side Drilled 4@90 Degrees, Polycarbonate Top Cover and Hole Plugs for Unused Drilling Locations.

Cut To Order Poles can be Side Drilled for 2@180 Degrees or 4@90 Degrees, Includes Polycarbonate Top Cover and Hole Plugs for Unused Drilling Locations.

Cut To Order Poles May Also Be Ordered With 2½" OD Tenons for Use With Post Top Decorative Luminaires, Flood/Area Slip Fitter Fixtures, or Any of a Wide Variety of Pole Top Mounting Accessories.

Our standard equipment is to make a top adapter with 2.5 inches. There is no opening on the top of the light pole. If ARM installation is needed, the top adapter shall be removed and holes shall be opened on the wall of the light pole. Finally, seal the top with a plastic rain cover.

4" Flange Dimensions	5" Flange Dimensions	Base Cover	Anchor Position Plate	Anchor Size

Available in	10FT	15FT	20FT	25FT
--------------	------	------	------	------

POLE, TENON & MOUNTS

PARKING LOTS & WALKWAYS

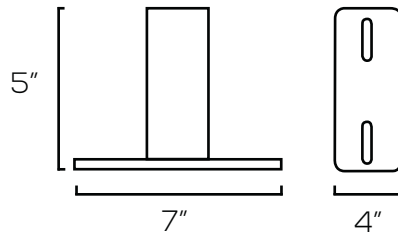

Flat Tenon, Rectangle

Compatibility: Square Pole, Wall
 Slip Fitter Size: 2 3/8" Minimum
 Materials: Bronzed Steel

#10745
 Rectangle

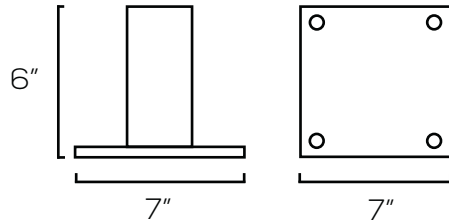

Flat Tenon, Square

Compatibility: Square Pole, Wall
 Slip Fitter Size: 2 3/8" Minimum
 Materials: Bronzed Steel

#10746
 Square

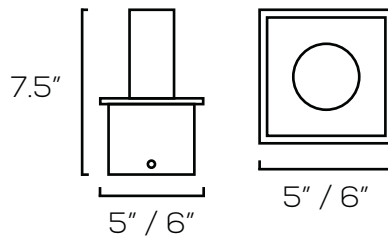

External Tenon, Square

Compatibility: 4" / 5" Square Pole
 Slip Fitter Size: 2 3/8" Minimum
 Materials: Bronzed Steel

#10748 4"
 #10747 5"

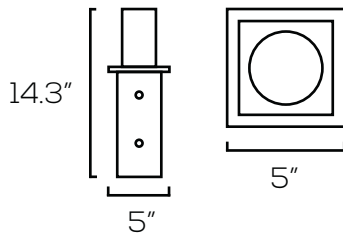

Internal Tenon, Square

Compatibility: 4" Square Pole
 Slip Fitter Size: 2 3/8" Minimum
 Materials: Bronzed Steel

#10756
 4"

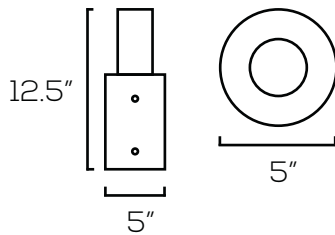

External Tenon, Round

Compatibility: 4" Round Pole
 Slip Fitter Size: 2 3/8" Minimum
 Materials: Bronzed Steel

#10750
 4"

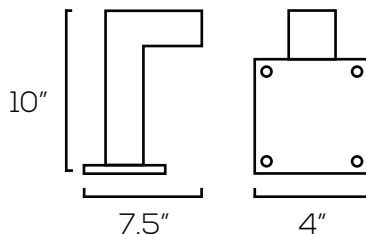

90° Bracket, Short

Compatibility: Square Pole, Wall
 Slip Fitter Size: 2 3/8" Minimum
 Materials: Bronzed Steel

#10751
 90°

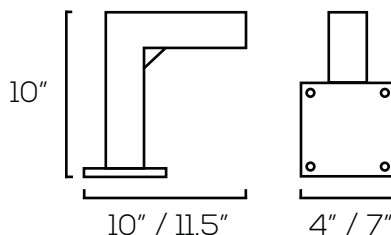

90° Bracket, Long

Compatibility: Square Pole, Wall
 Slip Fitter Size: 2 3/8" Minimum
 Materials: Bronzed Steel

#10961 4"
 #10752 7"

POLE, TENON & MOUNTS

PARKING LOTS & WALKWAYS

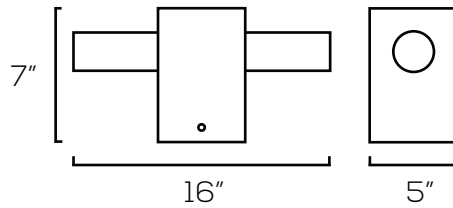

90° Two Head Bracket, Square

Compatibility: 4" Square Pole
 Slip Fitter Size: 2 3/8" Minimum
 Materials: Bronzed Steel

#10749
4"

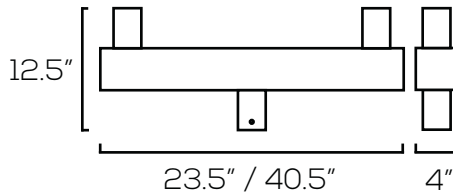

Two Head Bullhorn, Round

Compatibility: 4" Round Pole
 Slip Fitter Size: 2 3/8" Minimum
 Materials: Bronzed Steel

#10957 23.5" #10744 40.5"

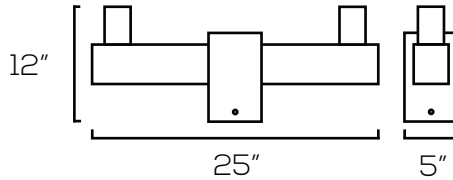

Two Head Bullhorn, Square

Compatibility: 4" Square Pole
 Slip Fitter Size: 2 3/8" Minimum
 Materials: Bronzed Steel

#10958
4"

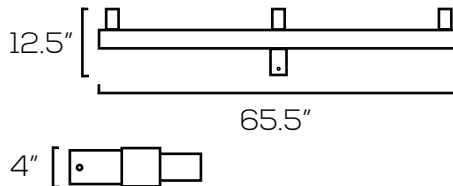

Three Head Bullhorn, Round

Compatibility: 4" Round Pole
 Slip Fitter Size: 2 3/8" Minimum
 Materials: Bronzed Steel

#10964
4"

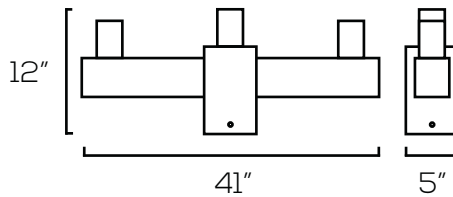

Three Head Bullhorn, Square

Compatibility: 4" Square Pole
 Slip Fitter Size: 2 3/8" Minimum
 Materials: Bronzed Steel

#10959
4"

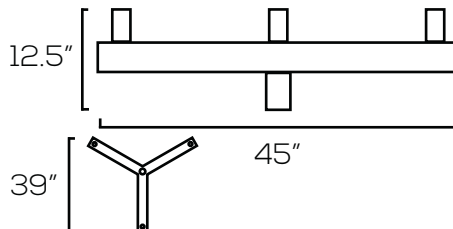

120° Three Head Bullhorn, Round

Compatibility: 4" Round Pole
 Slip Fitter Size: 2 3/8" Minimum
 Materials: Bronzed Steel

#10965
4"

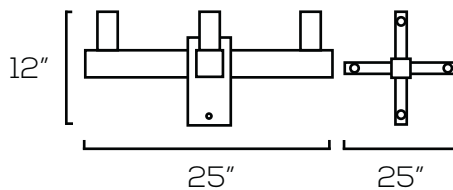

90° Four Head Bullhorn, Square

Compatibility: 4" Square Pole
 Slip Fitter Size: 2 3/8" Minimum
 Materials: Bronzed Steel

#10960
4"

DiscountLED



CONTEMPORARY EXTRUSION
BY DISCOUNT LED

UL & DLC CERTIFIED



1001 PROFILE

1001

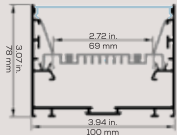

Surface & Suspended
Direct

5075

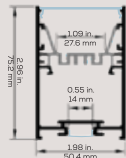

Surface & Suspended
Direct | Indirect

3875



Suspended
Direct | Indirect

7532

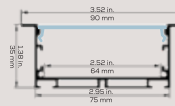

Recessed
Direct

5032

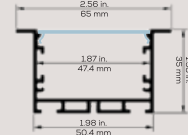

Recessed
Direct

5319

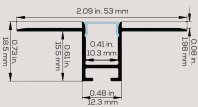

Recessed
Accent

5615

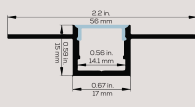

Recessed
Accent

5312

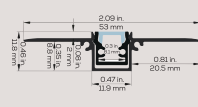

Recessed
Accent

2626

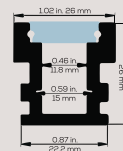

Recessed
Accent

2711

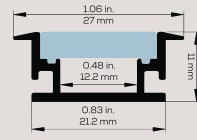

Recessed
Accent

CONTEMPORARY EXTRUSIONS PROFILES UNMATCHED VERSATILITY

The adaptability of our linear aluminum profiles are only matched by their quality and production speed. These lighting systems are booming in popularity as home and office owners hunt for futuristic recessed accent light elements and fixtures.

Contemporary series is far more than just accent lighting.

Create a strip of light that is recessed, surface mounted, or suspended. One run can stretch along the floor, then climb up a wall, and span across the ceiling with angled or intersecting pieces. When suspended, two models provide task lighting from one direction and accent light from the other.

Get custom linear extrusions:

- Sleek and trendy form factor, highly adaptable
- Design and assemble fixtures extremely quickly
- 6063-T5 aluminum maximizes LED lifespan
- PMMA and PC lenses: high clarity, no hotspots

1.

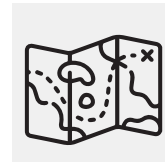

Pick a location and plan your mount type.

2.

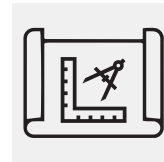

Take measurements and record notes.

3.

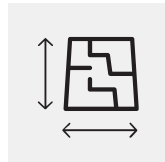

Draw a basic layout for your design idea.

4.

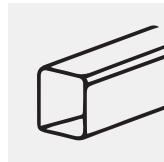

Choose a profile that fits your application.

7532 Recessed Task Light



1,850lm 11W/ft ↓

5312 Profile Recessed Accent Light



175lm 2.2W/ft ↓

5615 Profile Recessed Accent Light



760lm 5.5W/ft ↓

5319 Recessed Accent Light



760lm 5.5W/ft ↓

2626 Recessed Floor Light



760lm 5.5W/ft ↓

2711 Recessed Floor Light



760lm 5.5W/ft ↓

ITEM	NAME
12502	1001 Linear Profile
12502-G	1001 Gear Tray
12502-A	1001 End Caps
12502-H	1001 Frosted Lens
12652	65W Internal Driver
12502-F	180° Connectors
12502-I	90° Connectors
12502-J	X Module
12502-K	T Module
12502-L	L Module
12502-E	6.5' Suspension Kit
12500-G	Suspension Ring
12502-D	Surface Mount
12502-B	Inner Clip Kit
12502-C	Safety Cable
12503	5032 Linear Profile
12503-A	5032 End Caps
12503-D	5032 Frosted Lens
40662-F	CCT Remote
40662-A	30W External Driver
40662-B	60W External Driver
40662-C	96W External Driver
12503-C	180° Connectors
12503-B	Spring Clip Set

ITEM	NAME
12501	3875 Linear Profile
12501-F	3875 Direct Gear Tray
12501-G	3875 Indirect Gear Tray
12501-A	3875 End Caps
12501-H	3875 Frosted Lens
12651	23W Internal Driver
12650	44W Internal Driver
12501-J	X Module
12501-K	T Module
12501-L	L Module
12501-E	180° Connectors
12501-I	90° Connectors
12501-D	6.5' Suspension Kit
12500-G	Suspension Ring
12501-B	Inner Clip Kit
12501-C	Safety Cable
12509	7532 Linear Profile
12509-A	7532 End Caps
12509-C	7532 Frosted Lens
12653	69W External Driver
12509-B	Spring Clip Set
12500-N	3M Tape

ITEM	NAME
12506	5319 Linear Profile
12506-A	5319 End Caps
12506-B	5319 Frosted Lens
40662-F	CCT Remote
40662-A	30W External Driver
40662-B	60W External Driver
40662-C	96W External Driver
12508	5615 Linear Profile
12508-A	5615 End Caps
12508-B	5615 Frosted Lens
40662-F	CCT Remote
40662-A	30W External Driver
40662-B	60W External Driver
40662-C	96W External Driver
12507	5312 Linear Profile
12507-B	5312 Gear Tray
12507-A	5312 End Caps
12507-C	5312 Frosted Lens
40662-A	30W External Driver
40662-B	60W External Driver
40662-C	96W External Driver

ITEM	NAME
12500	5075 Linear Profile
12500-H	5075 Gear Tray
12500-A	5075 End Caps
12500-I	5075 Frosted Direct Lens
12651	23W Internal Driver
12650	44W Internal Driver
12500-F	180° Connectors
12500-O	5075 Frosted Indirect Lens
12500-L	T Module
12500-M	L Module
12500-K	X Module
12500-J	90° Connectors
12500-D	Surface Mount
12500-B	Inner Clip Kit
12500-C	Safety Cable
12500-G	Suspension Ring
12500-N	3M Tape
12500-E	6.5' Suspension Kit
12510	2711 Linear Profile
12510-A	2711 End Caps
12510-B	2711 Frosted Lens
40662-F	CCT Remote
40662-A	30W External Driver
40662-B	60W External Driver
40662-C	96W External Driver
12510-C	Mounting Clip

DiscountLED



LED T-BAR PANEL

OFFICE AND RETAIL STORES

UL & DLC CERTIFIED



LED T-BAR PANEL

OFFICE AND RETAIL STORES

OVERVIEW

These Led Panel were designed and engineered as maintenance free, energy-contamination of the night sky, while providing highly effective delivered lumens for indoor illumination at hotels, garages, commercial buildings, public spaces, schools, universities, and hospitals.



FEATURES

- ✓ Input Voltage: 100-277V AC, 50-60 Hz
- ✓ Waterproof Rating: IP40
- ✓ Warranty: 5 Years



PRODUCT SPECIFICATION

-	2*2, 40W	2*4, 55W
Watt	40W	55W
Lumens:	4800 lm	6600 lm
CCT:	5000K	5000K
Power Factor:	≥0.95	≥0.95
Efficacy:	120 lm/W	120 lm/W
CRI:	>80 Ra	>80 Ra
Dimensions:	2*2 ft	2*4 ft
Dimmable	0-10V	0-10V
THD:	≥10%	≥10%
Beam Angle:	120°	120°

DiscountLED

UNLEADED
2.399

DIESEL
2.809

Regular

CASH

Diesel

CASH

2.51⁹

2.89⁹

LED GAS PRICE SIGNS

GAS STATIONS

UL & DLC CERTIFIED



LED GAS PRICE SIGNS

GAS STATIONS



Watts: 64.4W
 Controller: RF Remote & App
 CCT: Red / Green / White
 Voltage: AC110V
 Dimmable: Light Sensor
 IP Rating: IP53
 Materials: Iron
 Finish: Black
 Lifespan: 100,000 hours

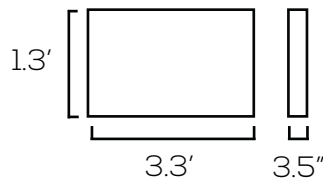

Watts: 242W
 Controller: RF Remote & App
 CCT: Red / Green / White
 Voltage: AC110V
 Dimmable: Light Sensor
 IP Rating: IP53
 Materials: Iron
 Finish: Black
 Lifespan: 100,000 hours

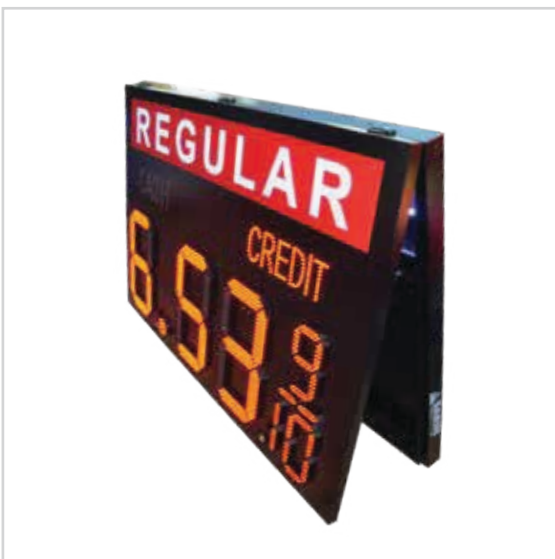
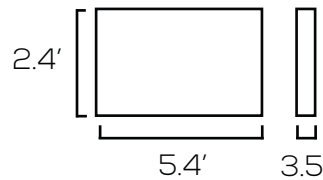

Watts: 90W
 Controller: RF Remote
 CCT: Red / White
 Voltage: AC110V
 Dimmable: Light Sensor
 IP Rating: IP65
 Materials: Iron, Acrylic
 Finish: Black
 Lifespan: >100,000 hours

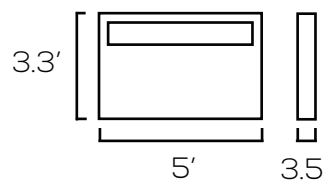

LED GAS PRICE SIGNS

GAS STATIONS



Watts: 415W
 Controller: RF Remote & App
 CCT: Red / Green / White
 Voltage: AC110V
 Dimmable: Light Sensor
 IP Rating: IP53
 Materials: Iron
 Finish: Black
 Lifespan: 100,000 hours

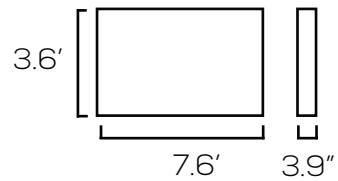

Watts: 557.6W
 Controller: RF Remote & App
 CCT: Red / Green
 Voltage: AC110V
 Dimmable: Light Sensor
 IP Rating: IP53
 Materials: Iron
 Finish: Black
 Lifespan: 100,000 hours

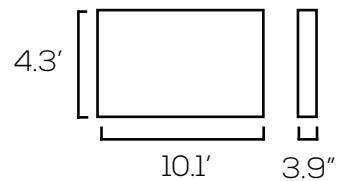

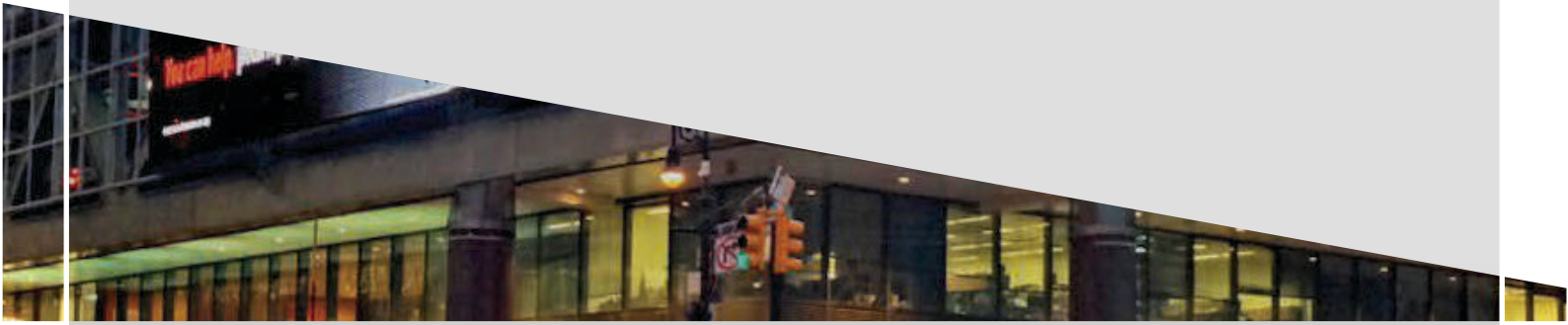

MOBILE ADS
AND THE BEST STRATEGIES



LED DIGITAL SIGNS

RENTAL, BILLBOARD & HD INDOOR DISPLAY

UL & DLC CERTIFIED

LED DIGITAL SIGNS

RENTAL, BILLBOARD & HD INDOOR DISPLAY

LIGHTWEIGHT DISPLAY

- ✓ Extremely Light Weight thin thickness
- ✓ Mixed splicing
- ✓ Fast Assembly
- ✓ Anti-damage Design
- ✓ Standard
- ✓ Concise



MUTUAL ASSEMBLY

500*500 mm and 500*1000 mm Cabinet can up-down mutual assembly. It reaches the demand for various dimension of the display



LED DIGITAL SIGNS

RENTAL, BILLBOARD & HD INDOOR DISPLAY

QUICK INSTALLATION

The left and right sides of the cabinet to retain the convex and concave step positioning to prevent the dislocation of the cabinets front and back during the installation;

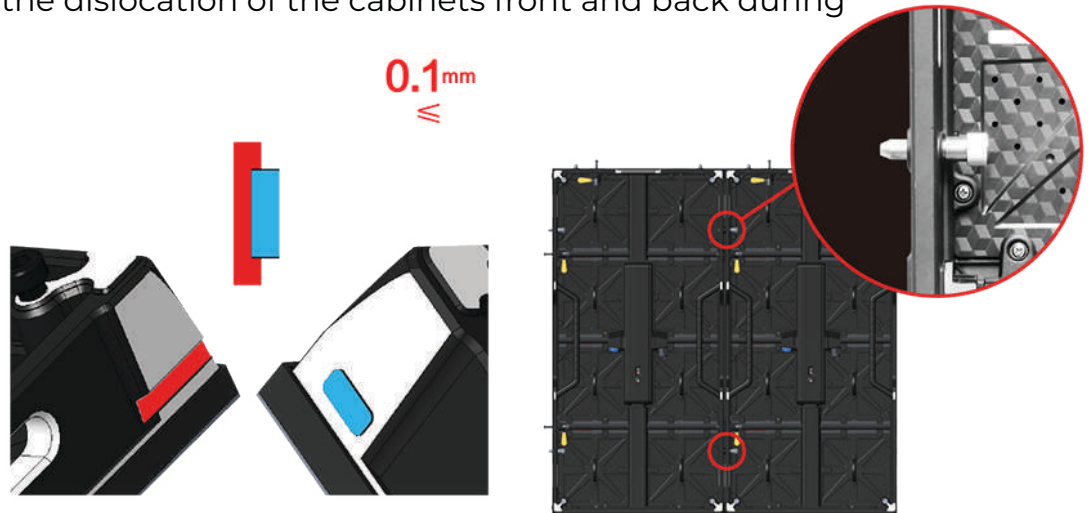

REDUCE THE NEED OF MAINTENANCE

Double protection against bump and welding

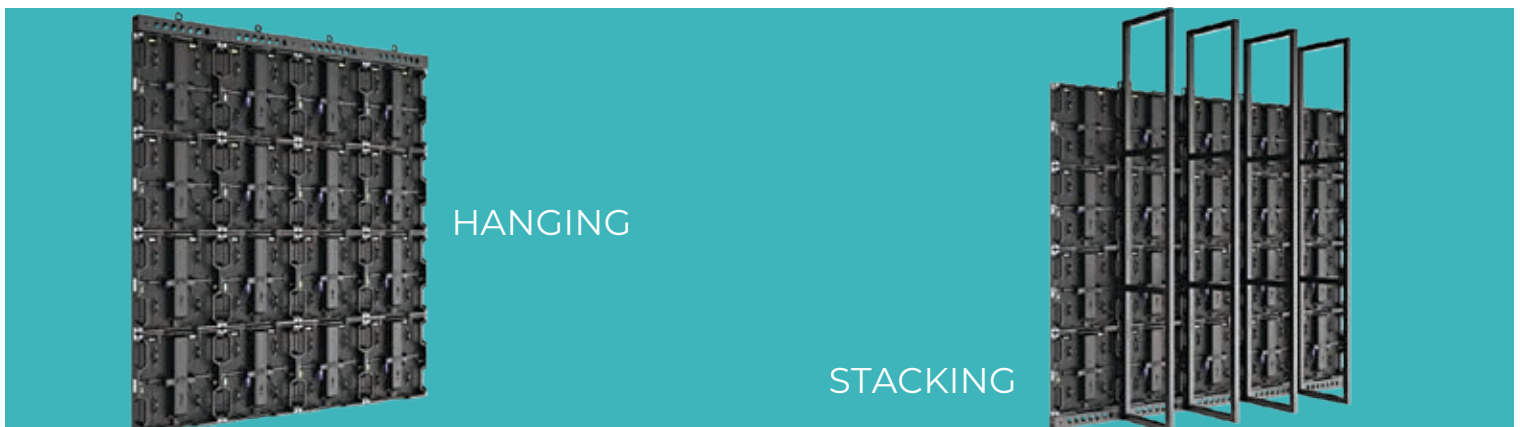
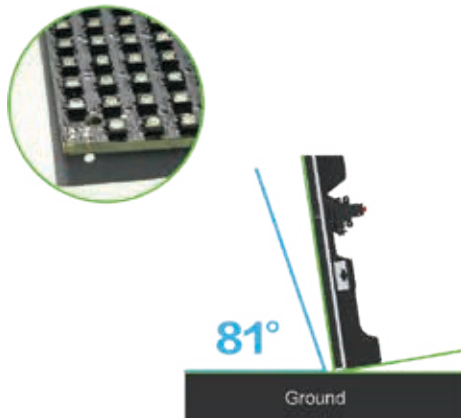

LED DIGITAL SIGNS INDOOR

RENTAL, BILLBOARD & HD INDOOR DISPLAY

MAIN FEATURES OF PANEL

1. Completely front service, everything could be taken out from the front, suitable to hanging, stacking and wall-mounted installation.
2. It adopts the whole Die-casting aluminum cabinet not just a frame, very safe for fixed project.
3. For wall-mounted installation, latch cabinets together by using a T-shape tool not screws, save time and labor on installation.

Module Parameters

Pixel Pitch	2.8mm
Dimensions (W x H)(mm)	250x250
Resolution (W x H)	89x89
Pixel Configuration (Nationstar)	SMD2020 Black face
Application	Indoor
Driving Mode	1/22 scan
Pixel Density(dots/module)	7921

Panel Parameters

Cabinet Dimension (W x H)(mm)	500*500*45mm / 19.68*19.68*1.77inch,
Physical Pixels (total) (dots / panel)	178 * 178
Module Quantity (pcs)	2 * 2
Material	Die-casting Aluminum
Power supply	UL listed
Maintenance access	front
Weight/Cabinet (kgs)	8.3KG / 18.3LBS
Warranty	2 years since pickup

Display Parameters

Pixel Density	123904dots/m ²	50W/panel
Brightness	≥900 cd/	150 W/panel
Refresh Rate	>3840Hz	AC110-240V±10%
Frame Frequency	60 Hz	50/60 Hz
Gray Scale	16bit	<1/10000
Brightness Control	256 grade	IP30
Viewing Angle	140°/140°	10%~96%

LED DIGITAL SIGNS OUTDOOR

RENTAL, BILLBOARD & HD INDOOR DISPLAY

MAIN SPECS FEATURES:

- * 500*500mm cabinet size, matched rear frame 500*500/1000/1500mm, after added the rear frame each Sq.meter only 42KG / 92.4LBS in total, thickness is 117mm / 4.606inches.
- * Using Nationstar Gold Wire RS LEDs, brightness up to 7500 nits.
- * 4 layers PCB board & silicon glue attached to the back of PCB board directly for better heat dissipation.

CABINET DESIGN:

- * 100% Die-casting aluminum cabinet and rear frame, location pins at two edges, get quick and high precision installation.
- * Each whole cabinet could be taken out from the front side quickly by specific tool.
- * Cutting 45° edge, it realizes straight, right angle, concave, convex and double-sides connections.

Module Parameters

Pixel Pitch	4.8mm
Dimensions (W x H)(mm)	250x250
Resolution (W x H)	52x52
Pixel Configuration (Nationstar)	SMD1921 Gold wire
Application	outdoor
Driving Mode	1/9 scan
Pixel Density(dots/module)	2704



Panel Parameters

Cabinet Dimension (W x H)(mm)	19.69*19.69*2.83inch /500*500*72mm
Physical Pixels (total) (dots / panel)	104 *104 pixels
Module Quantity (pcs)	2*2
Material	Die-casting Aluminum
Maintenance	100% front service
Power supply	UL Listed
Weight/Cabinet (kgs)	6KG / 13.2LBS per panel
Warranty	2 years



Display Parameters

Pixel Density	43264dots/m ²	50W/panel
Brightness	≥6000 cd/m ²	150 W/panel
Refresh Rate	>2400Hz	AC220-110V±10%
Frame Frequency	60 Hz	50/60 Hz
Gray Scale	65536 level	<1/10000
Brightness Control	256 grade	IP65
Viewing Angle	140°/140°	10%~96%

DiscountLED



**LED CUSTOM PRINTED
CEILING PANELS**

RENTAL, BILLBOARD & HD INDOOR DISPLAY

UL & DLC CERTIFIED

LED CUSTOM PRINTED CEILING PANELS

OFFICE AND RETAIL STORES

OVERVIEW

Discount LED custom printed LED Ceiling Panel features a vibrant lazy day SkyLens® and is a quick and easy alternative to traditional window skylights. The printed LED panel light is great for dental office lighting, hospital lighting, classroom lighting, waiting rooms, basements, and more. Because the panel's driver is built into its low-profile frame, the light can be surface mounted on walls or ceilings. It can also be mounted in suspended grid ceilings. The image is printed directly on the 2' x 4' LED panel diffuser. This backlit panel light uses Even-Glow® technology and an optical diffuser to deliver a smooth, flawless wall of illumination without visible bulbs or hot spots. Bright and powerful—the 72-watt dimmable LED light emits natural white illumination.

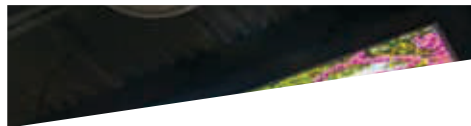

Contact us for your custom lit up ceiling

DiscountLED



LED EXIT SIGN

EMERGENCY AND RETAIL STORES

UL & DLC CERTIFIED



LED EXIT SIGN

EMERGENCY AND RETAIL STORES



Watts: 2W
 Voltage: AC120 - 277V
 Dimmable: No
 IP Rating: IP20
 Materials: Aluminum, ABS
 Finish: Reflective, Red
 Exit Sides: Single / Double
 Lifespan: 50,000 hours

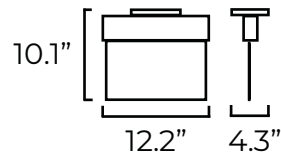

Optional: Green Letters



Watts: 5W
 Lumens: 300lm
 CCT: 6500K
 Voltage: AC120 - 277V
 Dimmable: No
 IP Rating: IP20
 Materials: ABS
 Finish: White, Red
 Lifespan: 50,000 hours

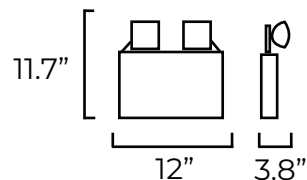

Watts: 1W
 Voltage: AC120 - 277V
 Dimmable: No
 IP Rating: IP20
 Materials: ABS
 Finish: White, Red
 Exit Sides: Single
 Lifespan: 50,000 hours

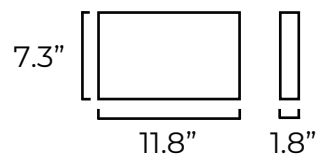

LED EXIT SIGN

EMERGENCY AND RETAIL STORES



Outdoor Exit Sign - 3W

Watts: 3W
Voltage: AC120 - 277V
Dimmable: No
IP Rating: IP65
Materials: ABS
Finish: White, Red
Exit Sides: Double
Lifespan: 25,000 hours

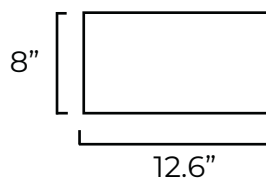

Emergency Light - 2.4W

Watts: 2.4W
Lumens: 240lm
CCT: 7000 - 9000K
Voltage: AC120 - 277V
Dimmable: No
IP Rating: IP20
Materials: ABS
Finish: White, Clear
Lifespan: 25,000 hours

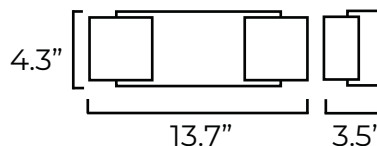

DiscountLED



**LED STRIP LIGHT, LED NEON FLEX,
ROPE LIGHT AND POWER SUPPLIES**
EMERGENCY AND RETAIL STORES

UL & DLC CERTIFIED

LED 360° FLEXIBLE STRIPS

OFFICE AND RETAIL STORES



OVERVIEW

Any corner places

Perfect for small channel letters

FEATURES

- ✓ Super Flexible 360° bendable
- ✓ UL cUL CE RoHS certified
- ✓ Double layer copper FPC
- ✓ 3-led(DC12V) and 6-led(DC24V) as unit can be cut by different length
- ✓ Blister package is available

PRODUCT SPECIFICATION

Power	10W/M
LED Qty	60-LEDs/M
Luminous Flux	980LM/M
Input Voltage	DC12V/24V
Size	5000*6mm/roll
Color	W/R/G/B/Y
Color Temp	6000K/4000K/3000K
PCB Width	6mm
Beam Angle	120°
CRI	≥80/≥90

LED FLEXIBLE STRIPS

OFFICE AND RETAIL STORES

OVERVIEW

- Cove and contour lighting
- Backlighting and Channel letter lighting
- Architectural decorative lighting
- Archway, canopy and bridge edge lighting



FEATURES

- ✓ Adopt high brightness SMD5050 as light source, 20-22lm/LED
- ✓ UL cUL CE RoHS certified
- ✓ Double layer copper FPC
- ✓ 3-led(DC12V) and 6-led(DC24V) as unit can be cut by different length
- ✓ Blister package is available

PRODUCT SPECIFICATION

Power	14.4W/M
LED Qty	60-LEDs/M
Luminous Flux	960LM/M
Input Voltage	DC12V/24V
Size	5000*6mm/roll
Color	W/R/G/B/Y/RGB
Color Temp	6000K/4000K/3000K
PCB Width	10mm
Beam Angle	120°
CRI	≥80/≥90

SIDE VIEW LED FLEXIBLE STRIPS

OFFICE AND RETAIL STORES

OVERVIEW

- Cove and contour lighting
- Backlighting and Channel letter lighting
- Architectural decorative lighting
- Archway, canopy and bridge edge lighting

FEATURES

- ✓ Adopt brightness SMD335 as light source, 5-6lm/LED
- ✓ UL cUL CE RoHS certified
- ✓ Double layer copper FPC
- ✓ 3-led(DC12V) and 6-led(DC24V) as unit can be cut by different length
- ✓ Blister package is available



PRODUCT SPECIFICATION

Power	9.6W/M
LED Qty	60-LEDs/M
Luminous Flux	600LM/M
Input Voltage	DC12V/24V
Size	5000*6mm/roll
Color	W/R/G/B/Y/WW
Color Temp	6000K/4000K/3000K
PCB Width	08mm
Beam Angle	120°
CRI	≥80/≥90

DIGITAL LED FLEXIBLE STRIPS

OFFICE AND RETAIL STORES

OVERVIEW

- Cove and contour lighting
- Backlighting and Channel letter lighting
- Architectural decorative lighting
- Archway, canopy and bridge edge lighting



FEATURES

- ✓ Adopt brightness SMD5050 as light source, 5-61m/LED
- ✓ UL cUL CE RoHS certified
- ✓ Double layer copper FPC
- ✓ 1-led(DC5V) and 3-led(DC12V) as unit can be cut by different length
- ✓ Each LED can be controlled separately

PRODUCT SPECIFICATION

Power	9W/M
LED Qty	60-LEDs/M
Luminous Flux	/
Input Voltage	DC5V/12V
Size	5000*10mm/roll
Color	Dream Color
Color Temp	R620-630 G520-530 B460-470NM
PCB Width	10mm
Beam Angle	120°
CRI	≥80/≥90

LED ROPE LIGHT STRIPS

OFFICE AND RETAIL STORES

OVERVIEW

- Cove and contour lighting
- Backlighting and Channel letter lighting
- Architectural decorative lighting
- Archway, canopy and bridge edge lighting



FEATURES

- ✓ It is convenient and stability with high power(50/100m each roll,no need driver)
- ✓ UL cUL CE RoHS certified
- ✓ Double layer copper FPC
- ✓ Every 1M can be cut by different length
- ✓ IP65 Protection

PRODUCT SPECIFICATION

Power	6W/M
LED Qty	60-LEDs/M
Luminous Flux	600LM/M
Input Voltage	AC110V/220V
Size	10000*6mm/roll
Color	W/R/G/B/Y
Color Temp	6000K/4000K/3000K
PCB Width	06mm
Beam Angle	120°
CRI	≥70/≥80

LED MODULES

OFFICE AND RETAIL STORES

FEATURES

- ✓ Adopt high brightness SMD5730/SMD2835 as light source
- ✓ Use ultrasonic technology, unique structure, better waterproof grade IP68
- ✓ ABS injection model, special lens design, 1600 optical lens and light evenly
- ✓ ETL, CE, RoHS certified
- ✓ Applicable for fish tank, pool, fountain, pond etc place for decoration or accent lighting.

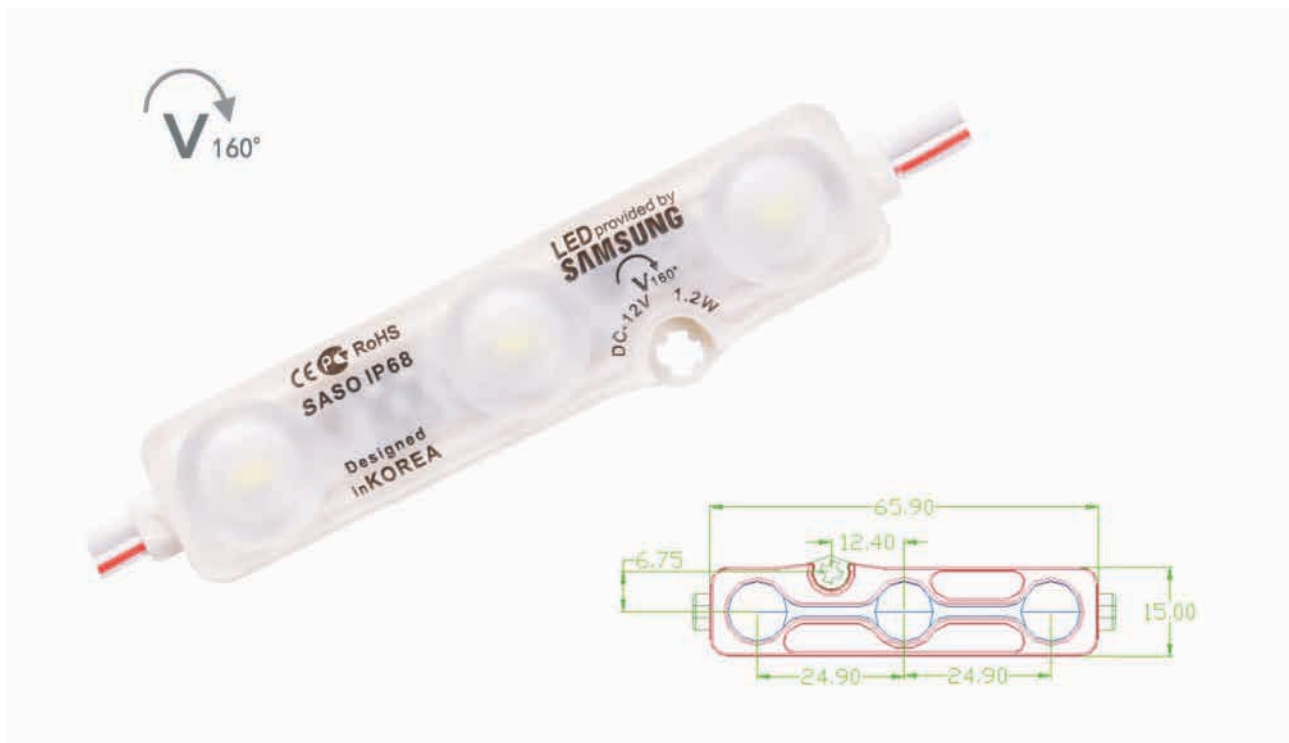

PRODUCT SPECIFICATION

Power	1.2W
LED Type	3x SMD5730
Lumen	100-120LM
Color	W/R/G/B/Y
Dimension	66*15*7.5MM
Voltage	DC12V

TRADITIONAL INJECTION LED MODULES

OFFICE AND RETAIL STORES

FEATURES

- ✓ Adopt high brightness SMD5050/SMD5730 as light source
- ✓ White/Black ABS injection shell,nice apperance and fire rating to UL94V-0
- ✓ Surface with silicon glue,well sealed,anti-dusting,anti-moisture,waterproof
- ✓ ETL,CE,RoHS certified
- ✓ Applicable for 6-18cm depth signage



PRODUCT SPECIFICATION

Power	0.72W
Voltage	DC12V
Lumen	60-66LM
Color	W/R/G/B/Y/RGB
LED Type	3x SMD5050
Dimension	67*19*5.9mm



PRODUCT SPECIFICATION

Power	0.96W
Voltage	DC12V
Lumen	80-88LM
Color	W/R/G/B/Y/RGB
LED Type	4x SMD5050
Dimension	51*32*5.9mm

LED POWER SUPPLY & CONTROLLER

OFFICE AND RETAIL STORES

NON-WATERPROOF LED POWER SUPPLY



POWER	INPUT VOLTAGE	OUTPUT VOLTAGE
150 W	AC100-240V	DC12V,125A/DC24V.6.25A
300 W	AC100-240V	DC12V,25A/DC24V.16.6A

WATERPROOF LED POWER SUPPLY



POWER	INPUT VOLTAGE	OUTPUT VOLTAGE
100 W	AC100-240V	DC12V,8.3A/DC24V.4.15A
200 W	AC100-240V	DC12V,16.6A/DC24V.8.3A

RGB CONTROLLER



PRODUCT NAME

TOUCH RGB CONTROLLER

DESCRIPTION

RGB LED controller with wireless touch-color RF remote to control your RGB LED light strips. Choose from 29 dynamic color-changing modes with adjustable speed and brightness levels or from static color and white modes with adjustable brightness levels, and control your light strip from up to 65' away. The remote is completely touch activated with a color wheel for direct, fine-tuned color selection. The remote also has power, pause, brightness control, dynamic mode selection, and speed-selection touch buttons.

DiscountLED

LIGHTING AND SIGNS

CREATING INDUSTRY STANDARDS



(833) 347-2533 | info@discountled.us
11261 Harry Hines Blvd Suite A120 Dallas TX 75229

DiscountLED

LIGHTING AND SIGNS

CREATING INDUSTRY STANDARDS



LIGHTNING CATALOGUE

www.discountled.us

(833) 347-2533 | info@discountled.us
11261 Harry Hines Blvd Suite A120 Dallas TX 75229